

1

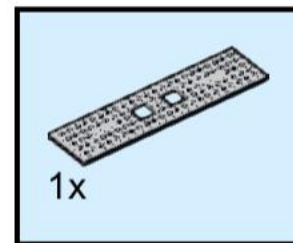

2

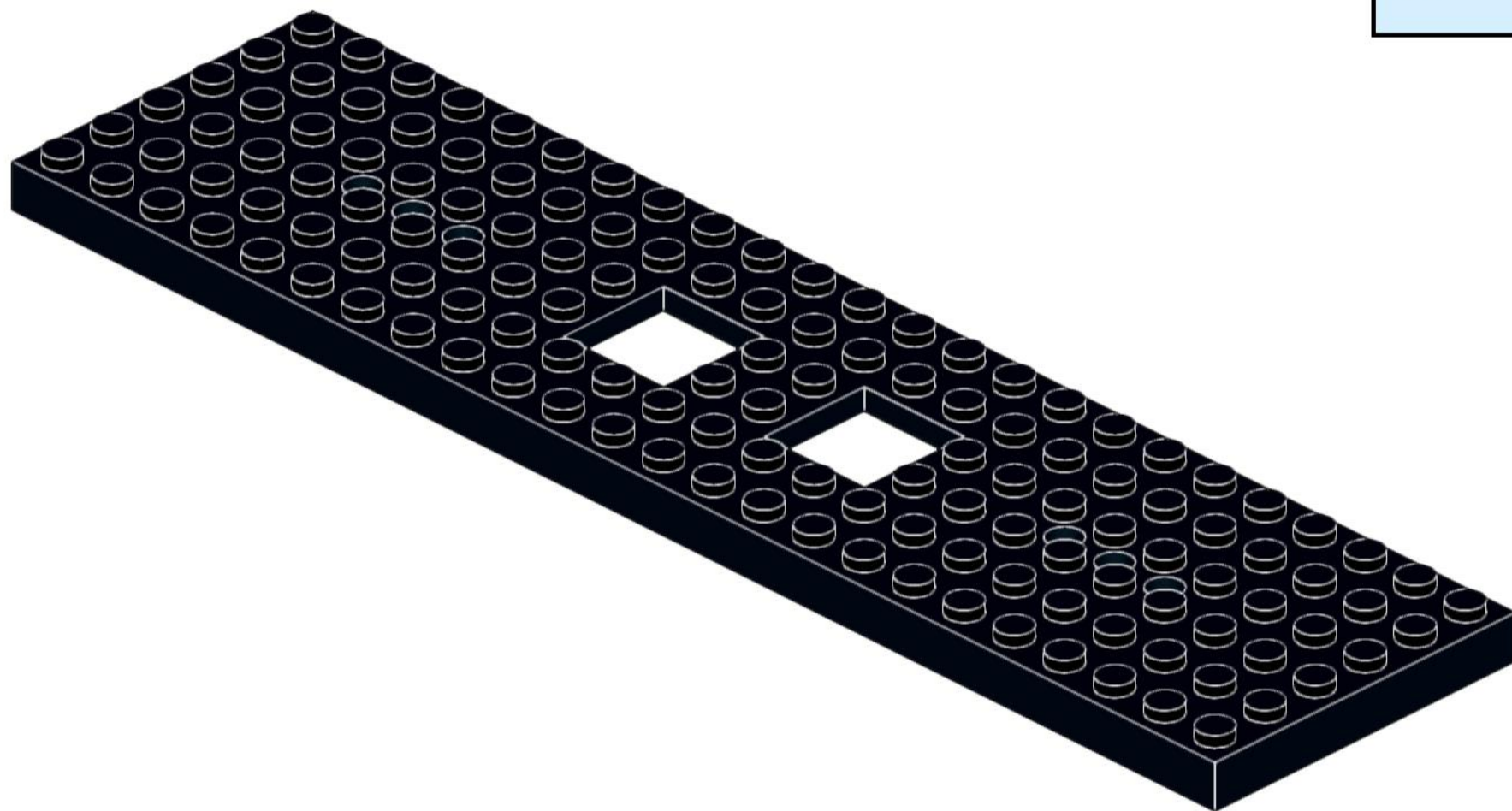
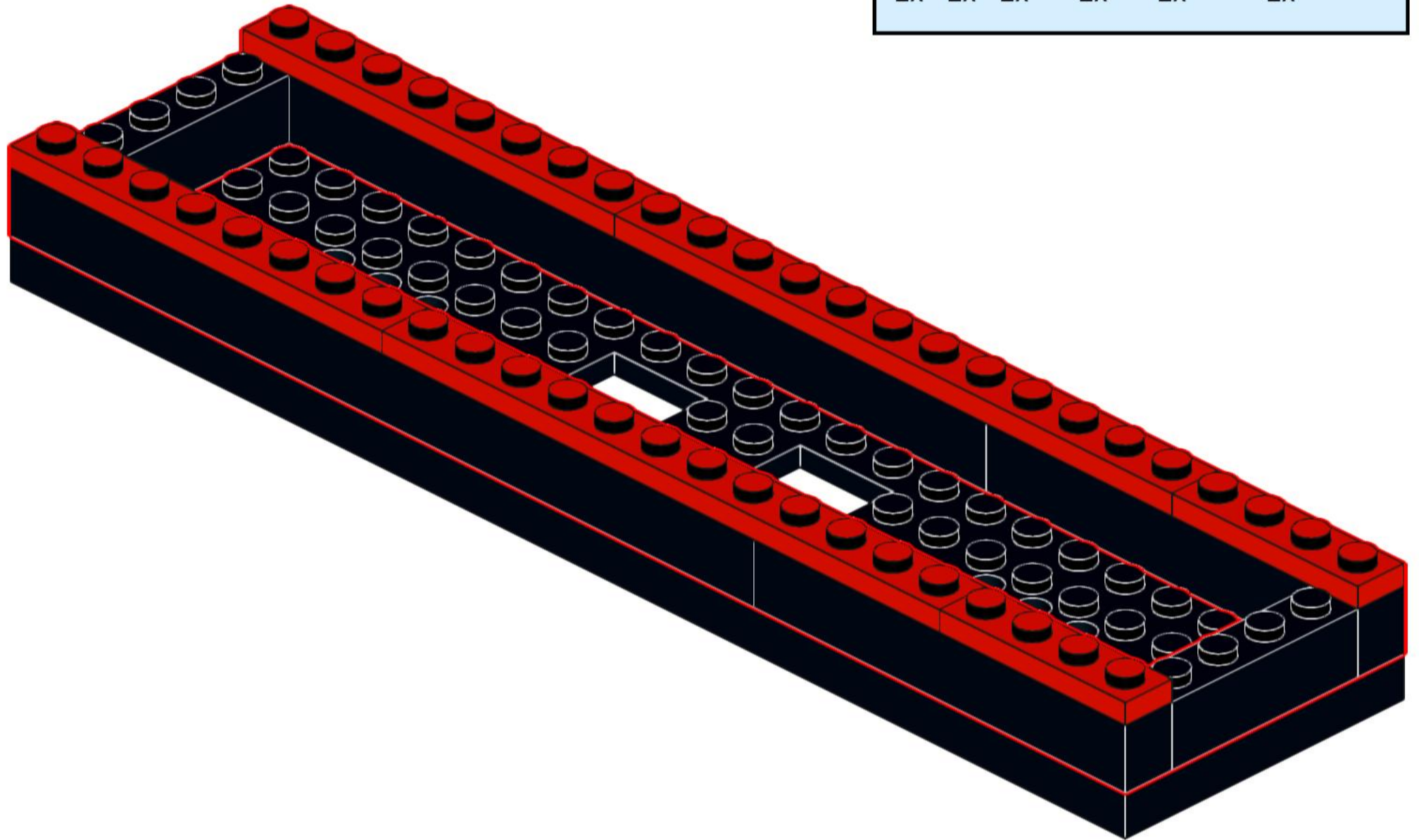

3

- 1x
- 3x
- 1x
- 3x
- 2x
- 1x
- 1x
- 1x
- 2x
- 1x
- 2x
- 1x
- 1x

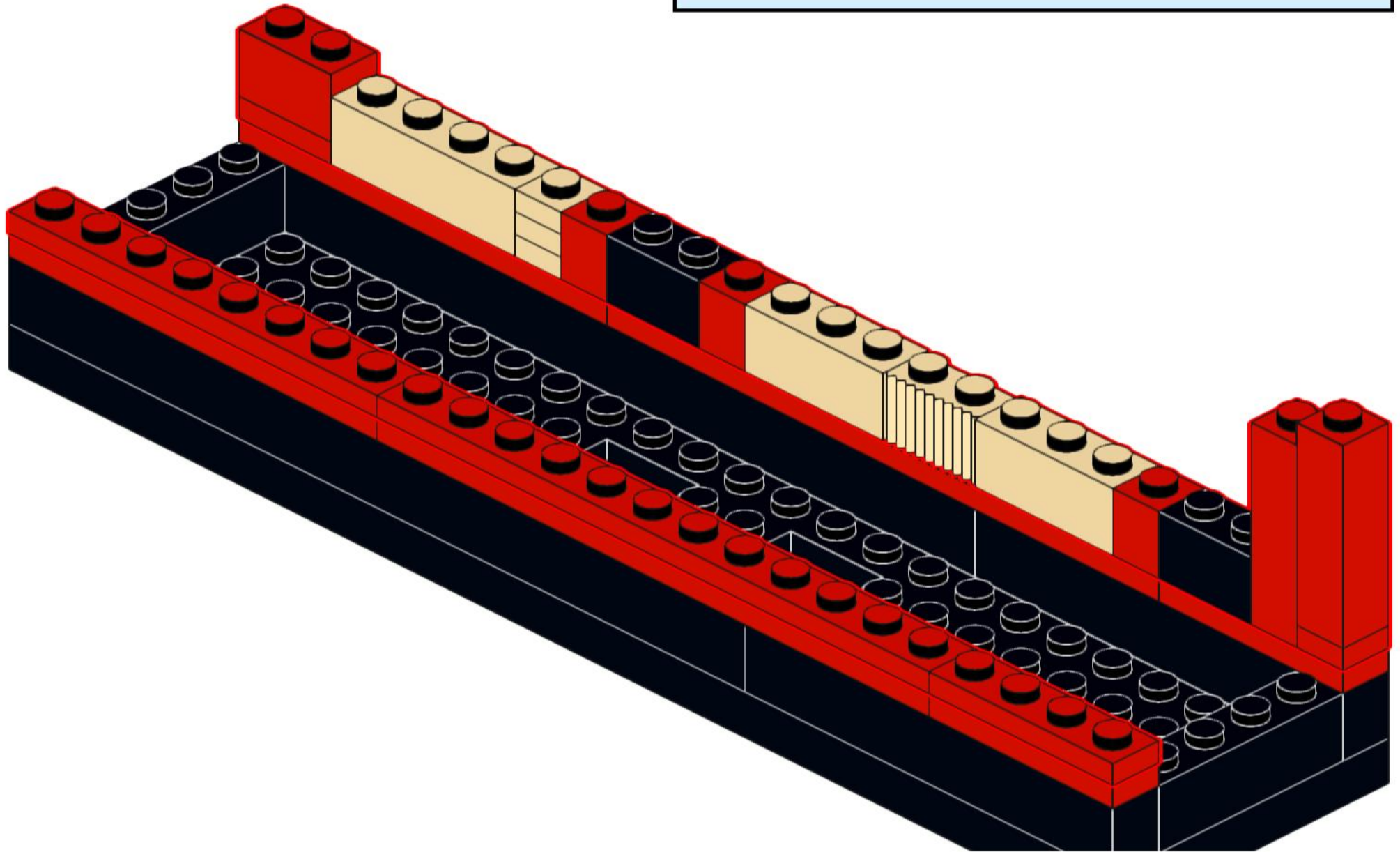

4

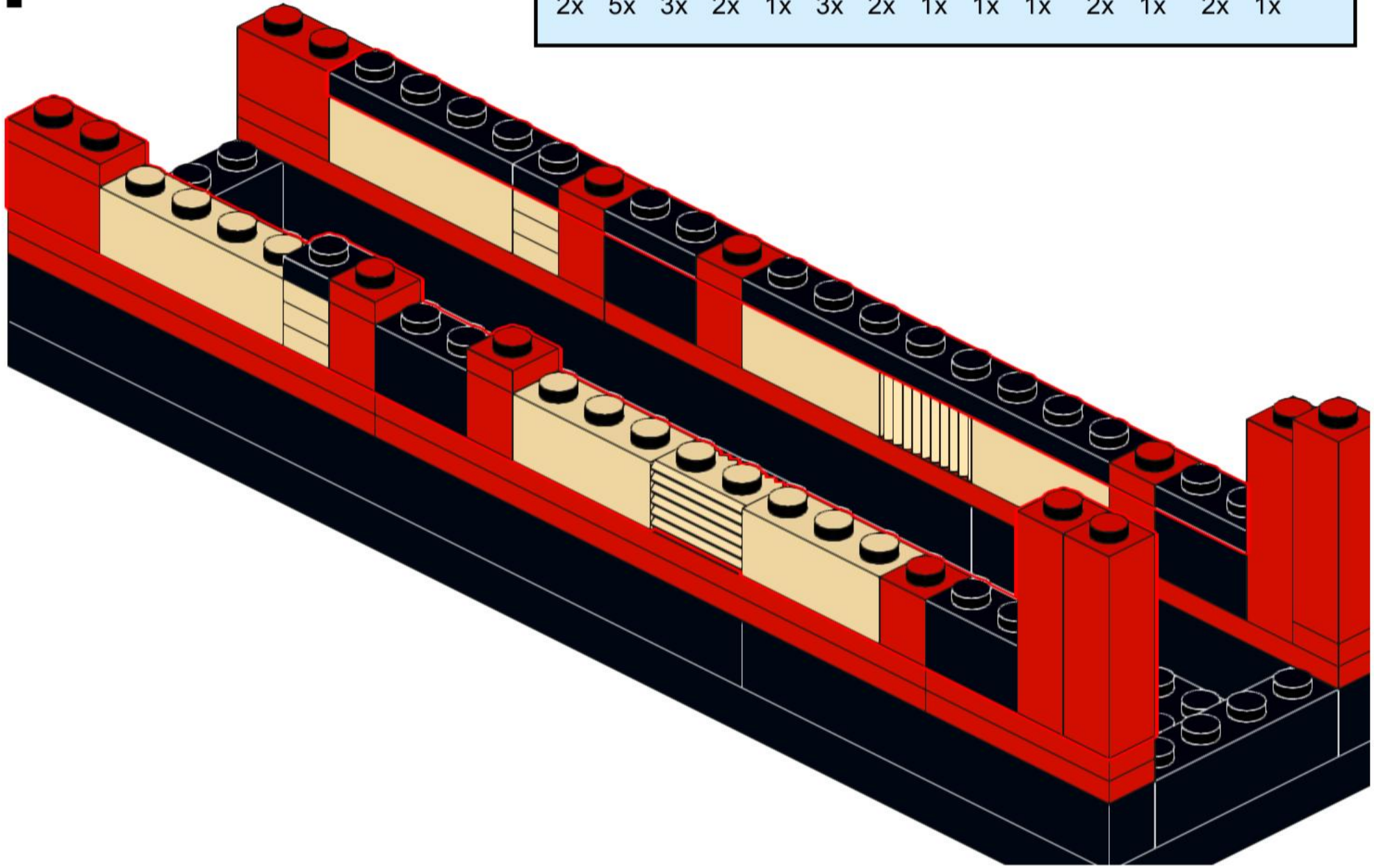
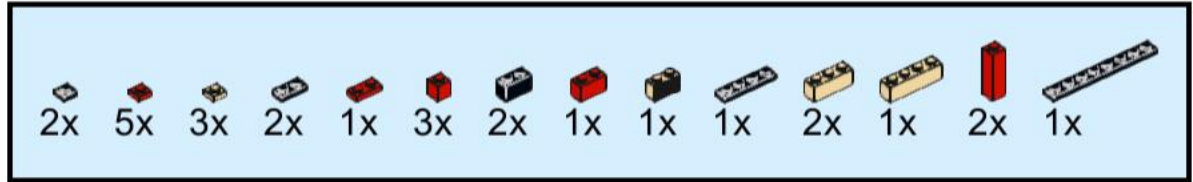

5

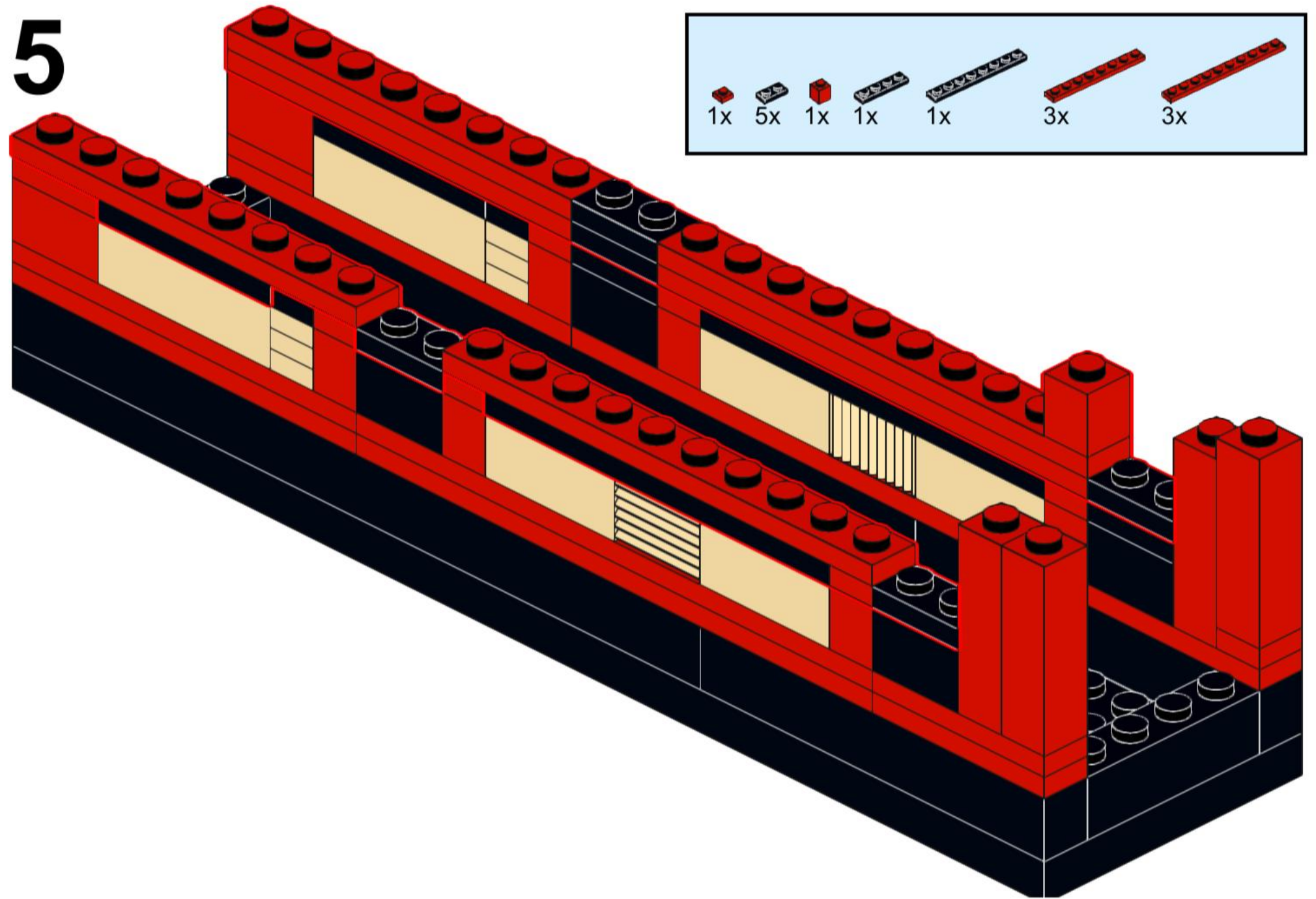

6

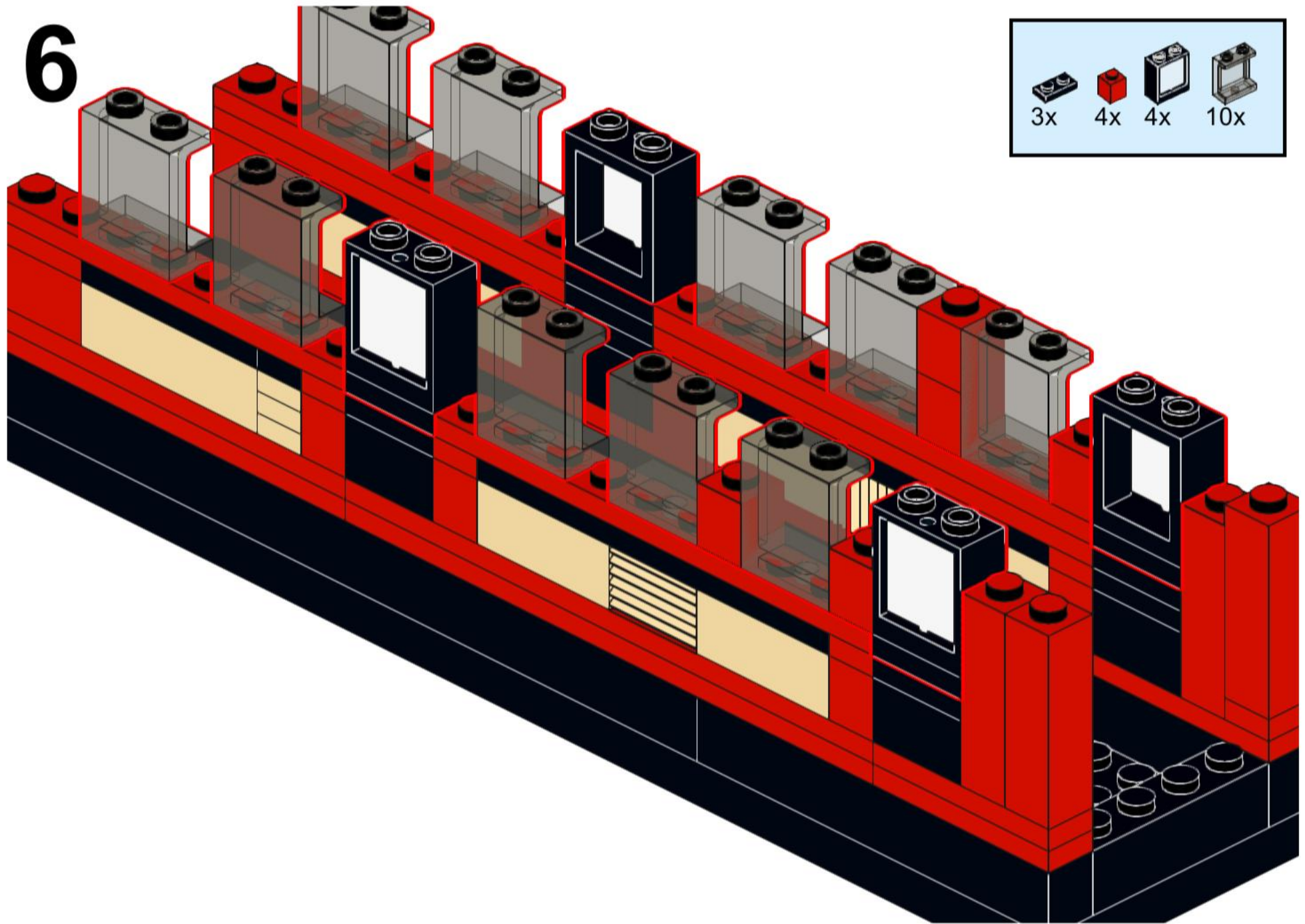

3x 4x 4x 10x

7

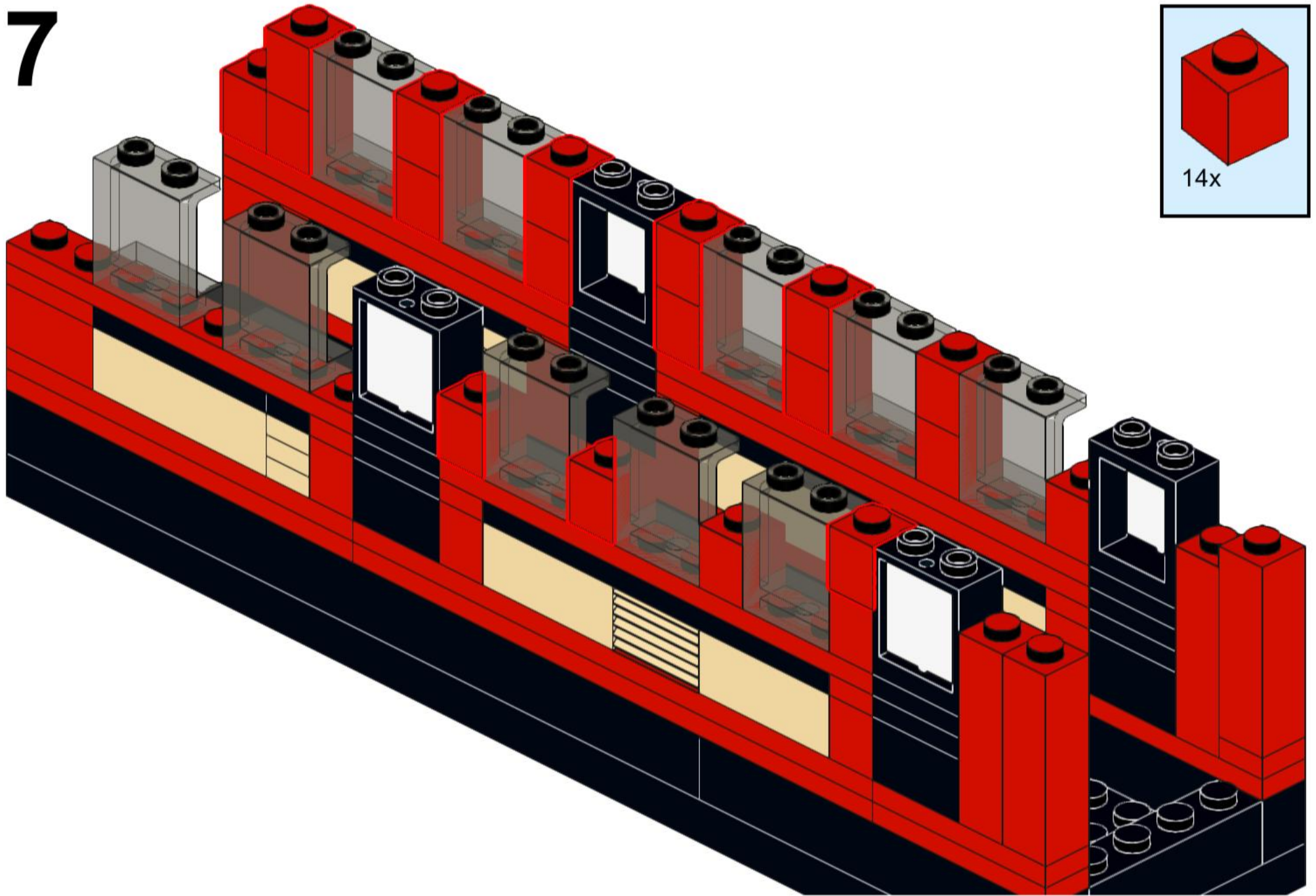

8

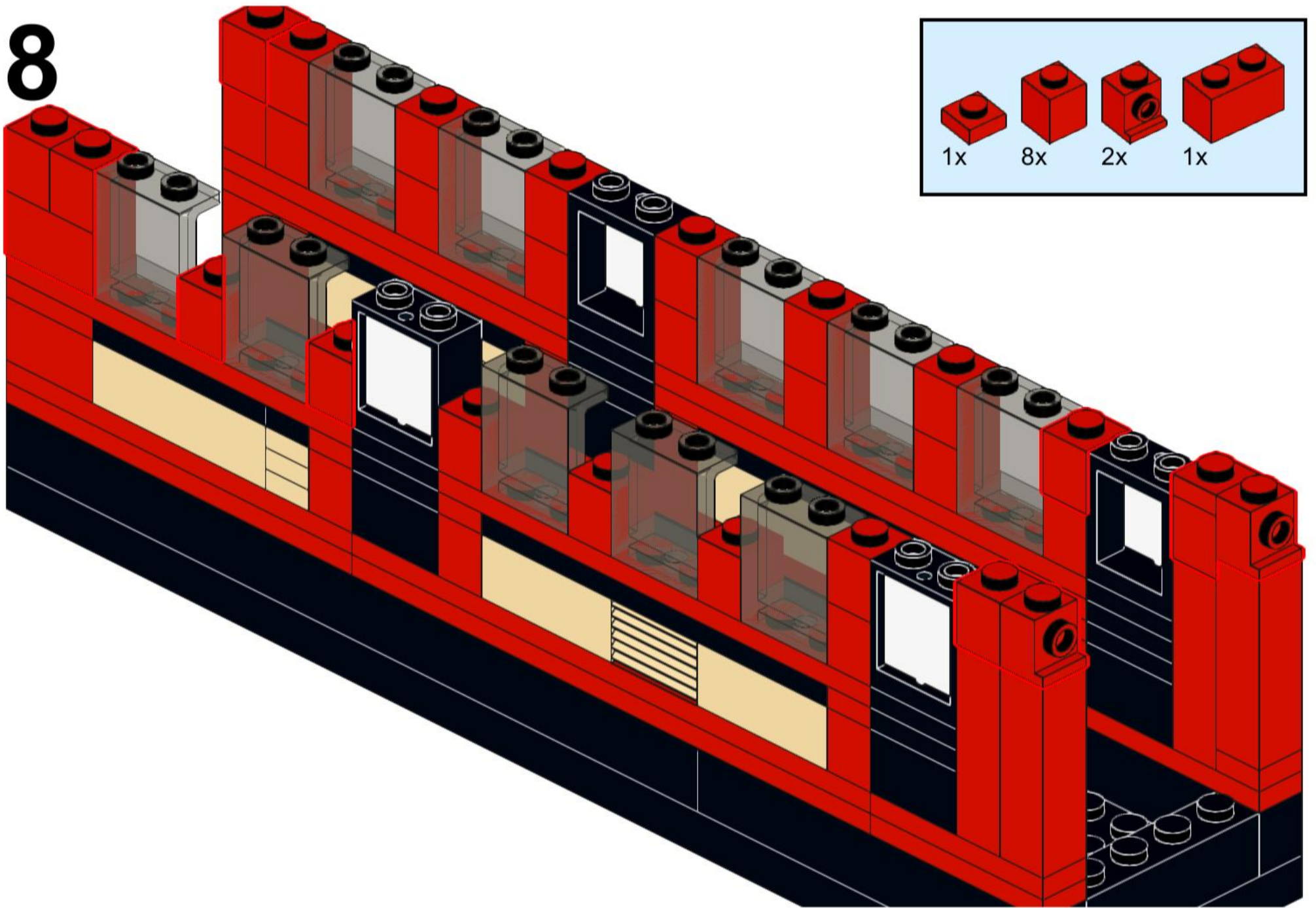

9

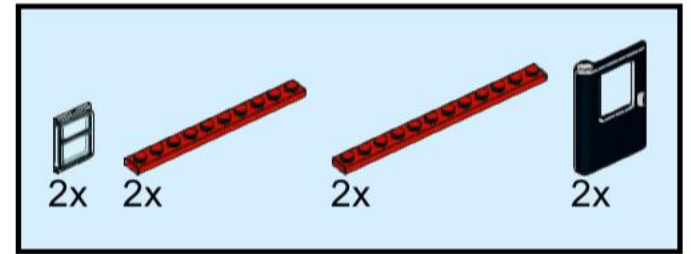
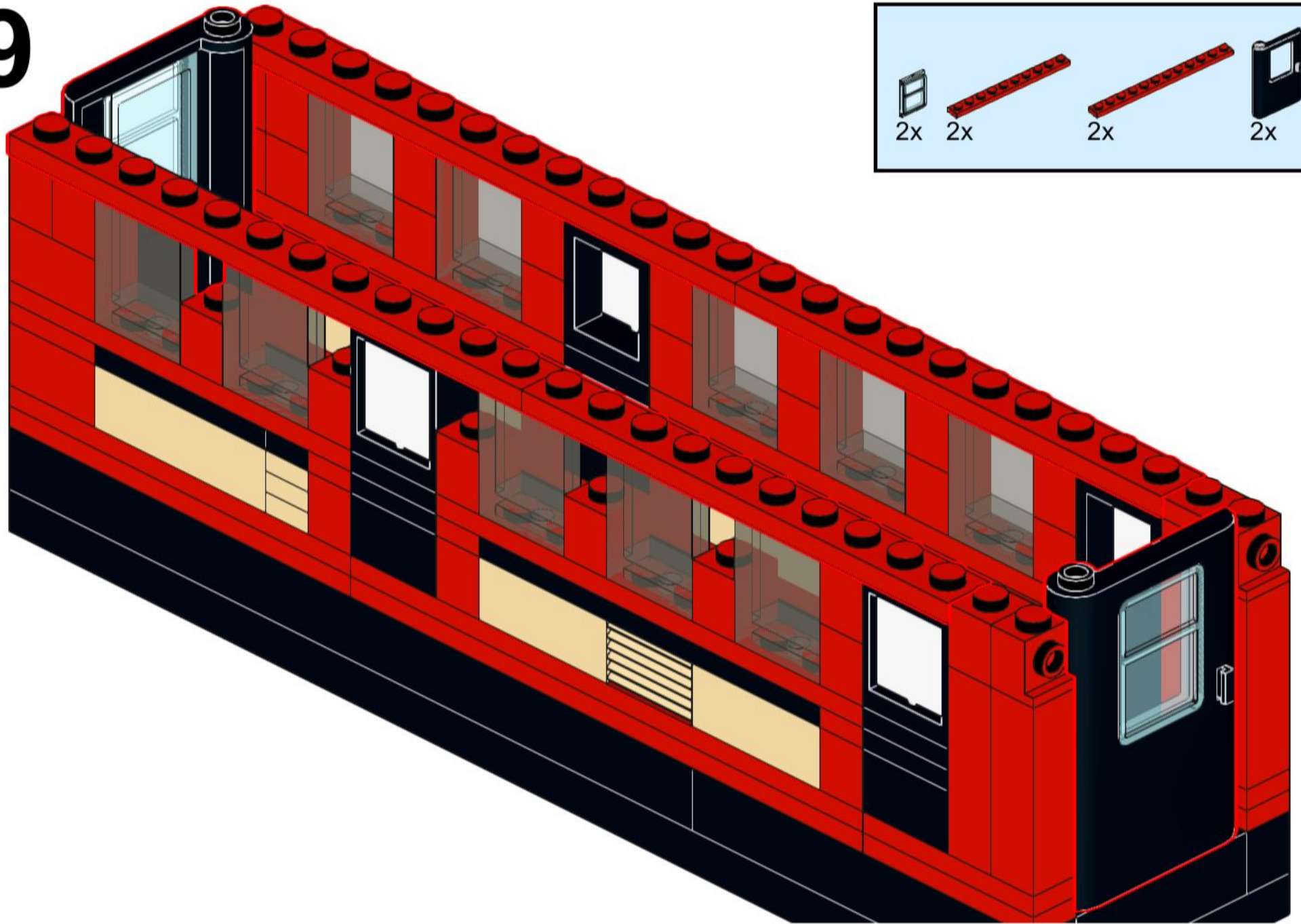

10

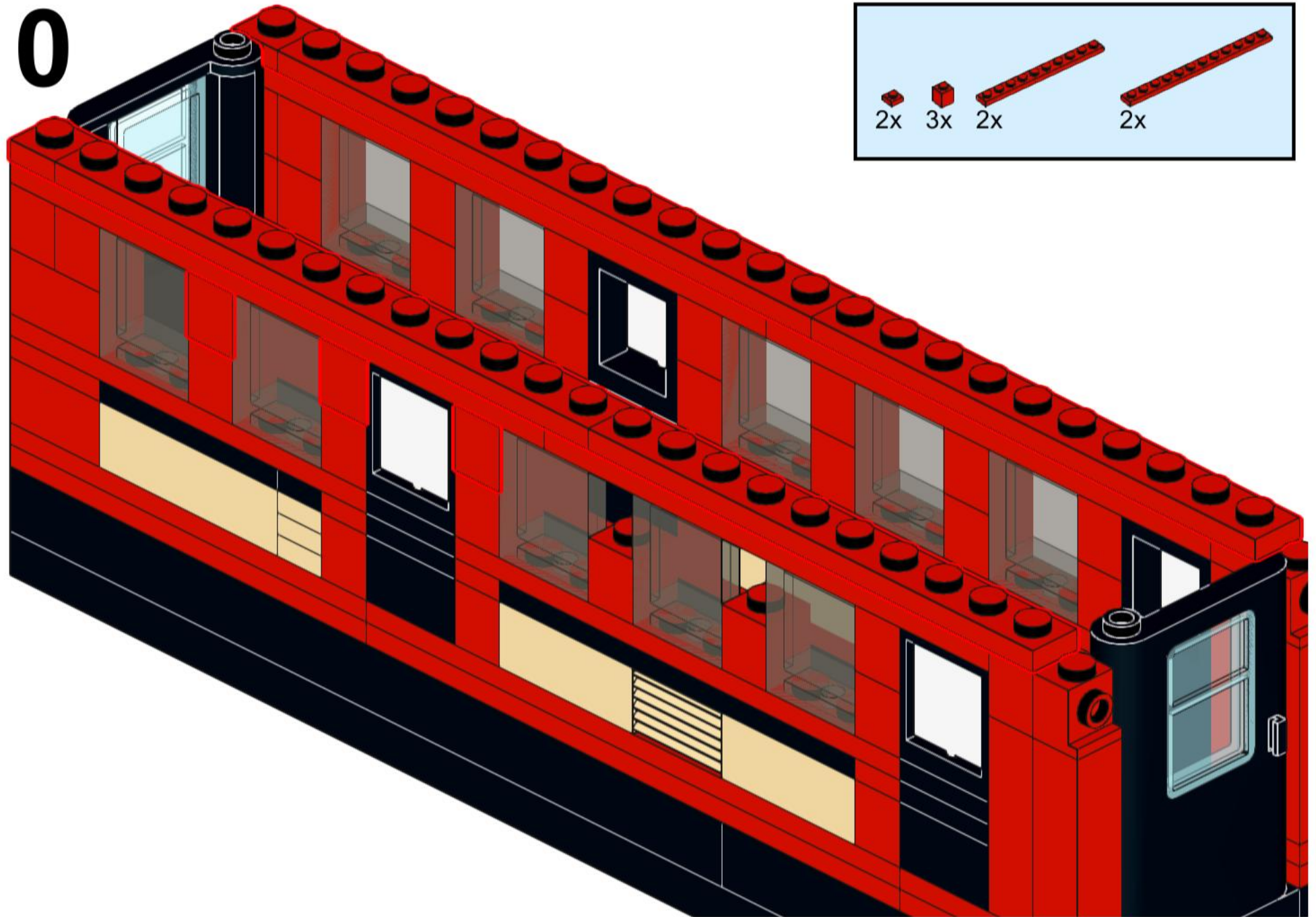
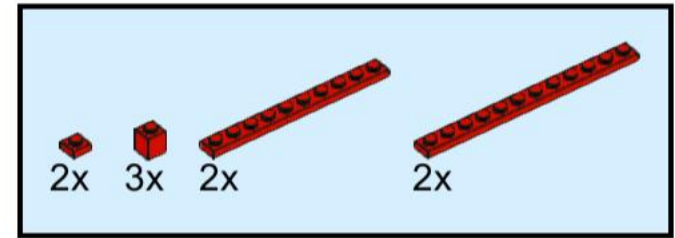

11

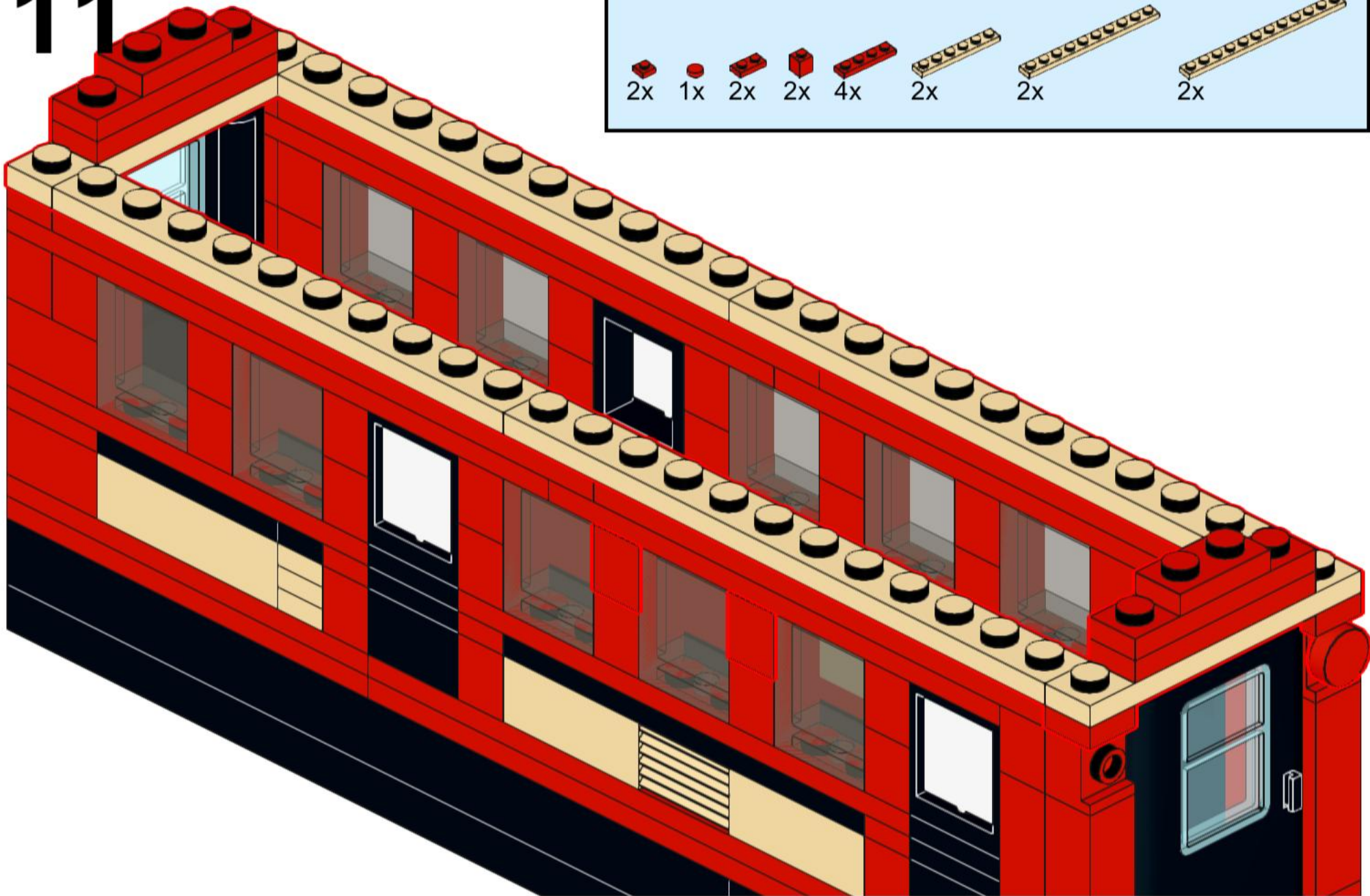
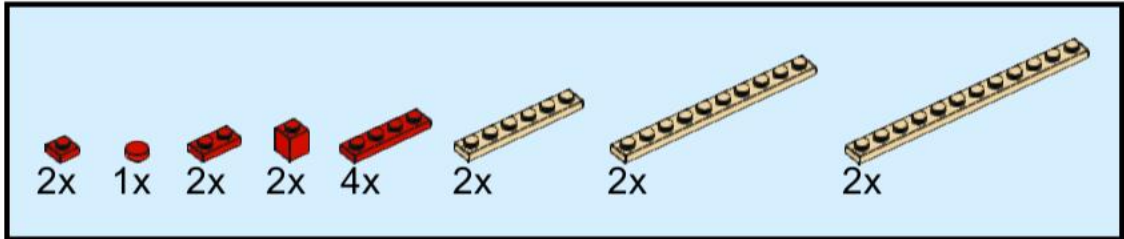

12

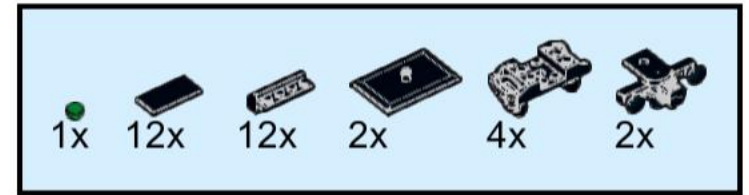
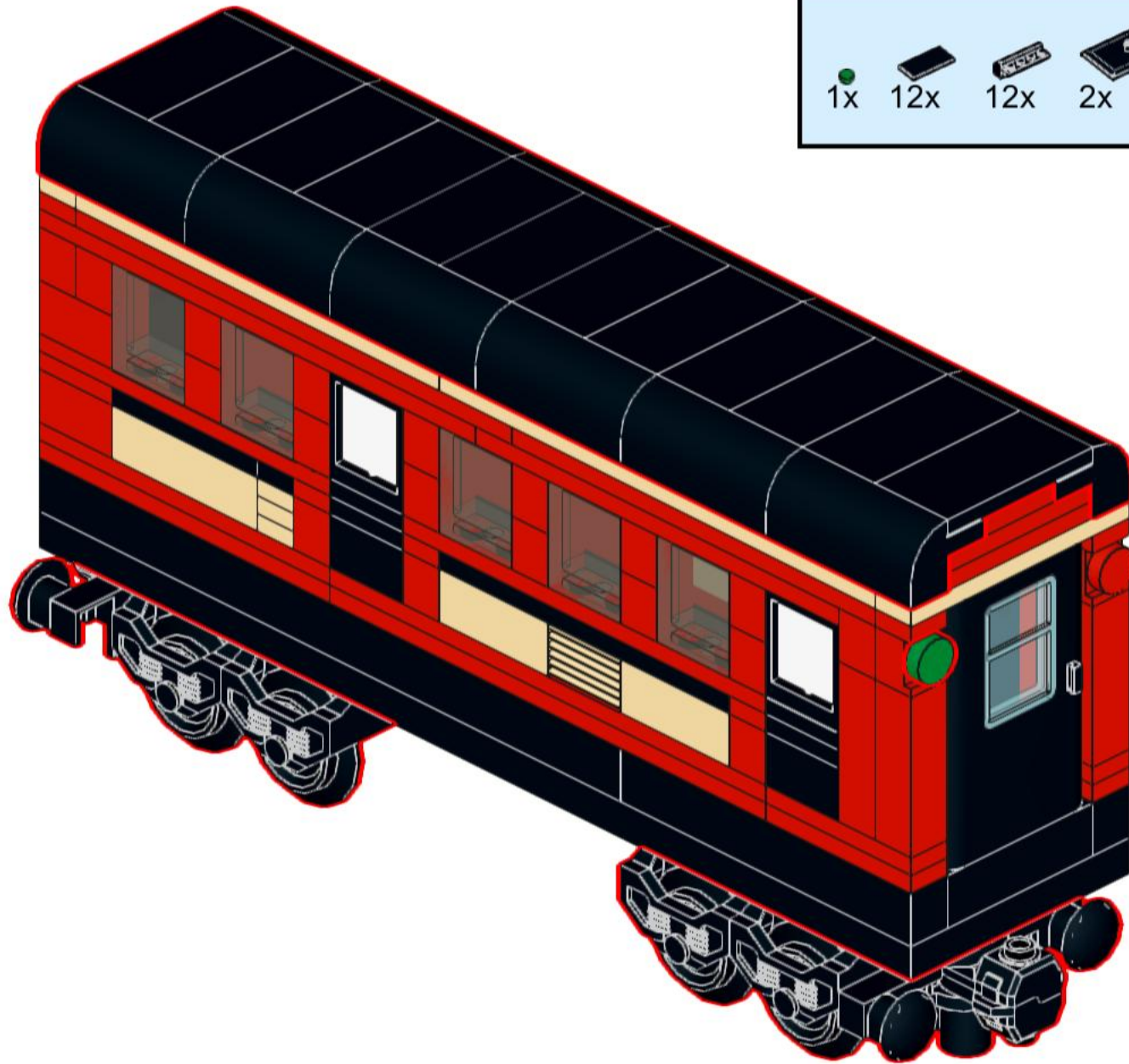

1x

12x

12x

2x

4x

2x

We hope you enjoyed
constructing this
carriage, if you
encounter any problems
call us and we will
arrange a zoom meeting
to help you