

1

Carriage on 28 stud base

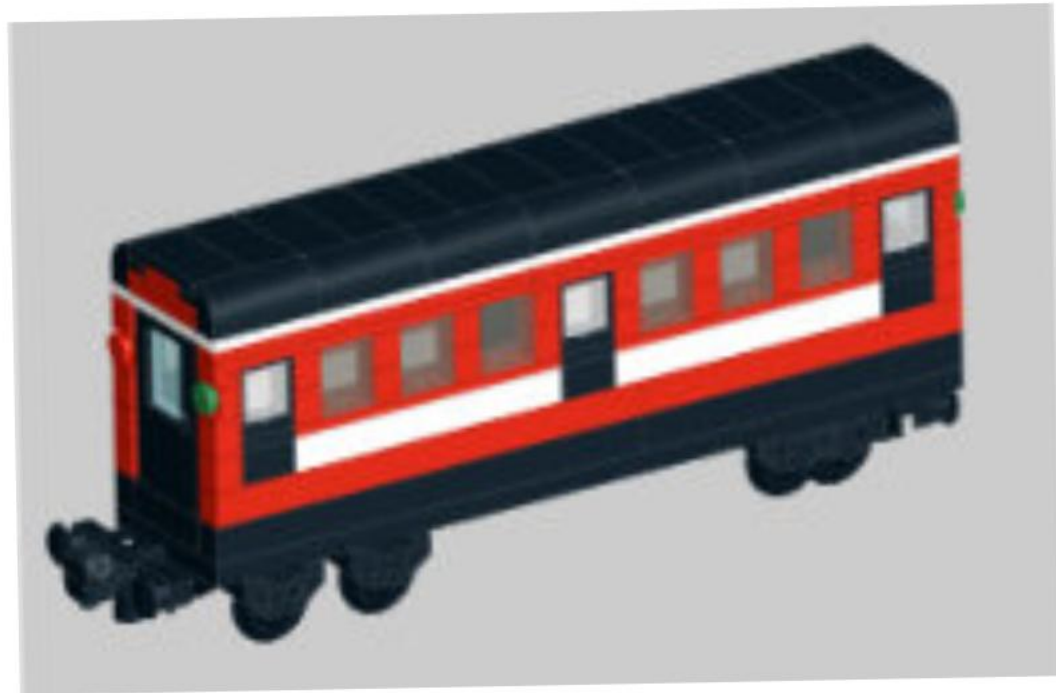

2

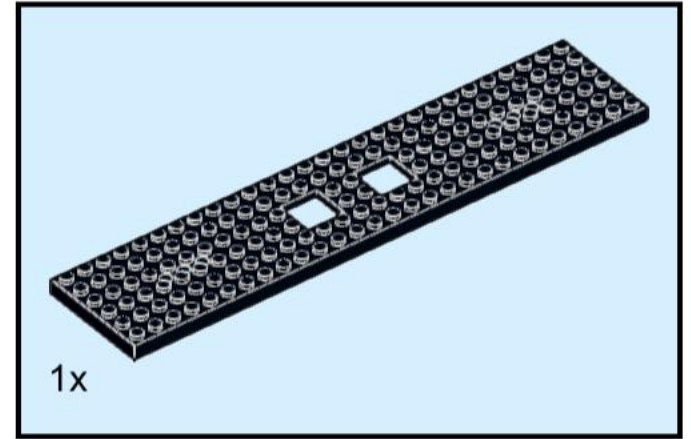
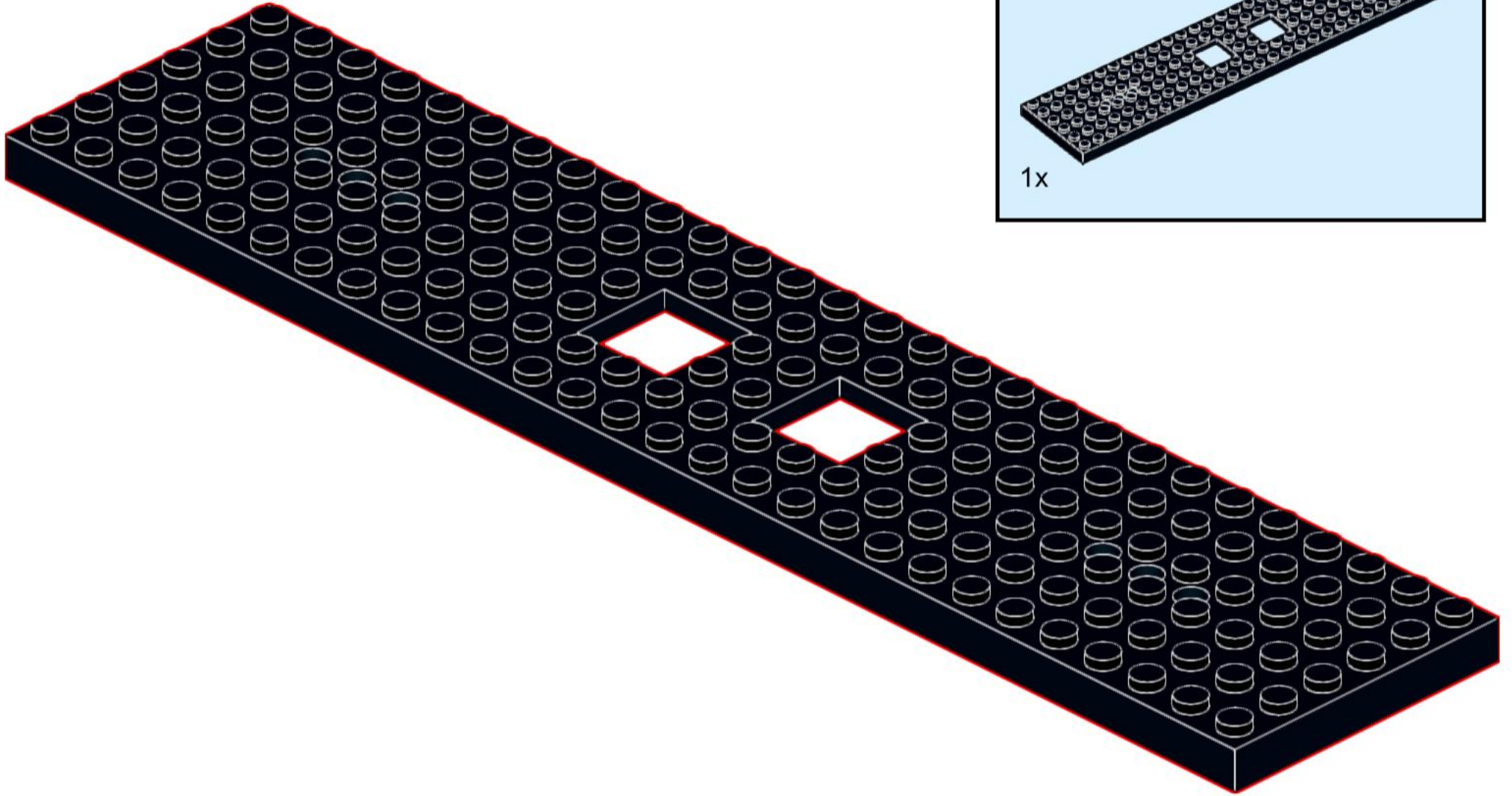

3

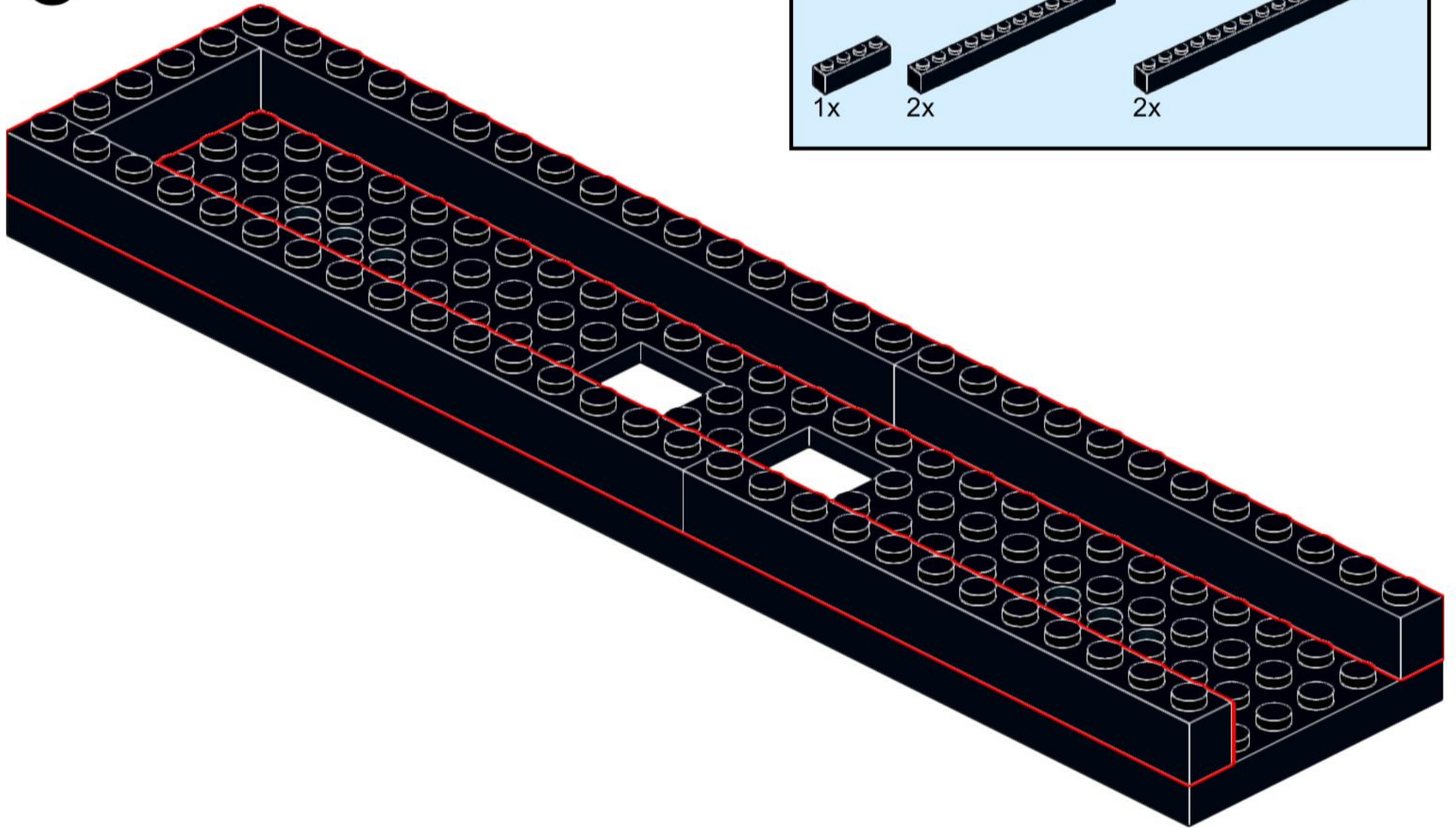

4

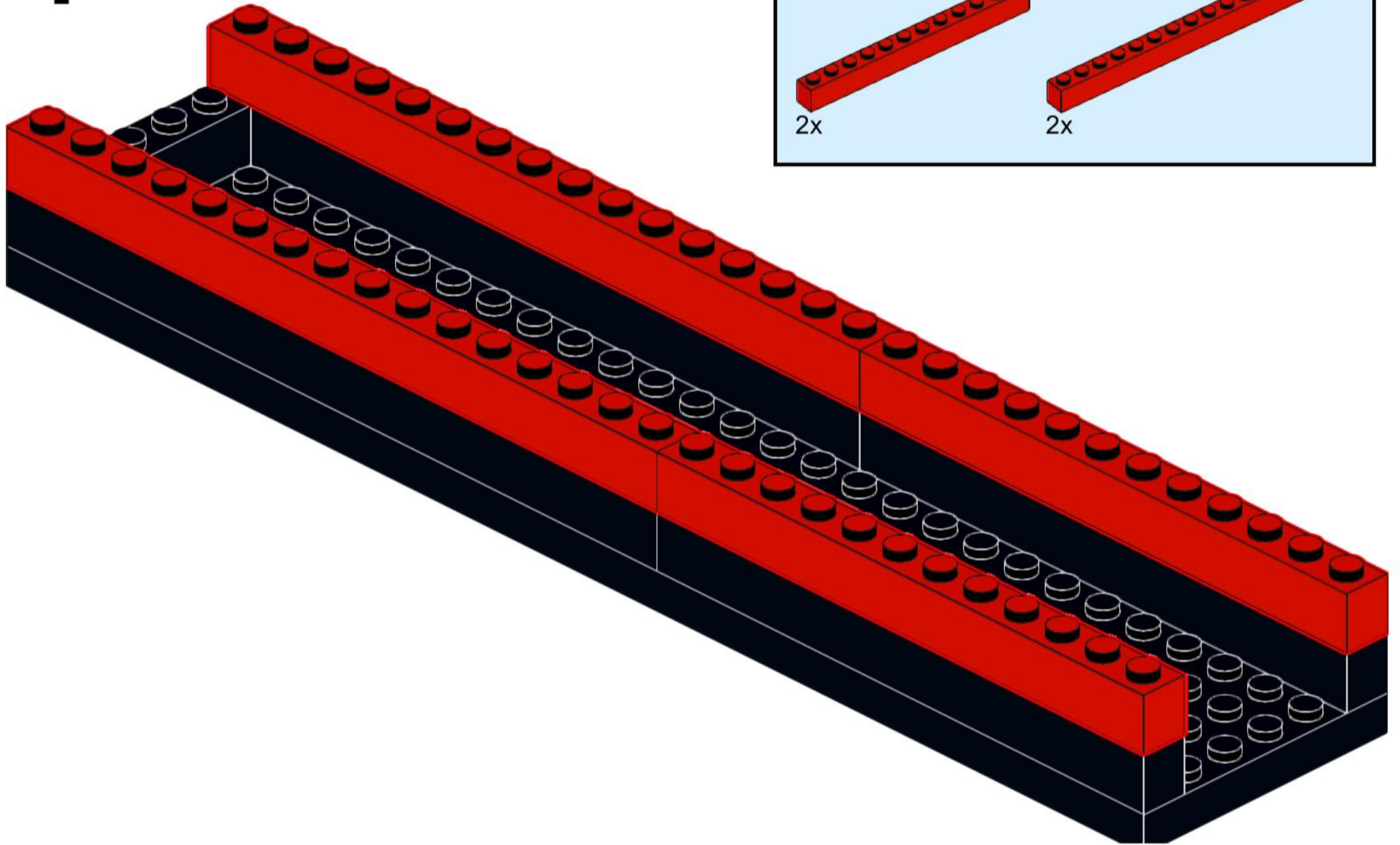

5

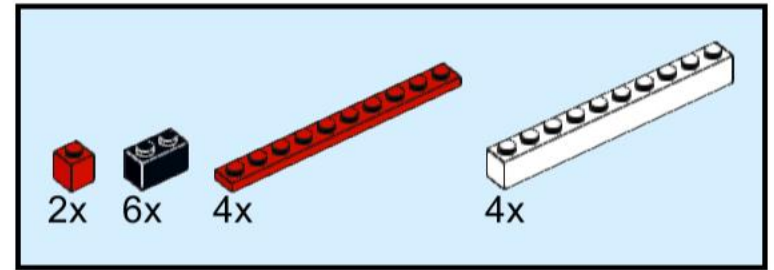
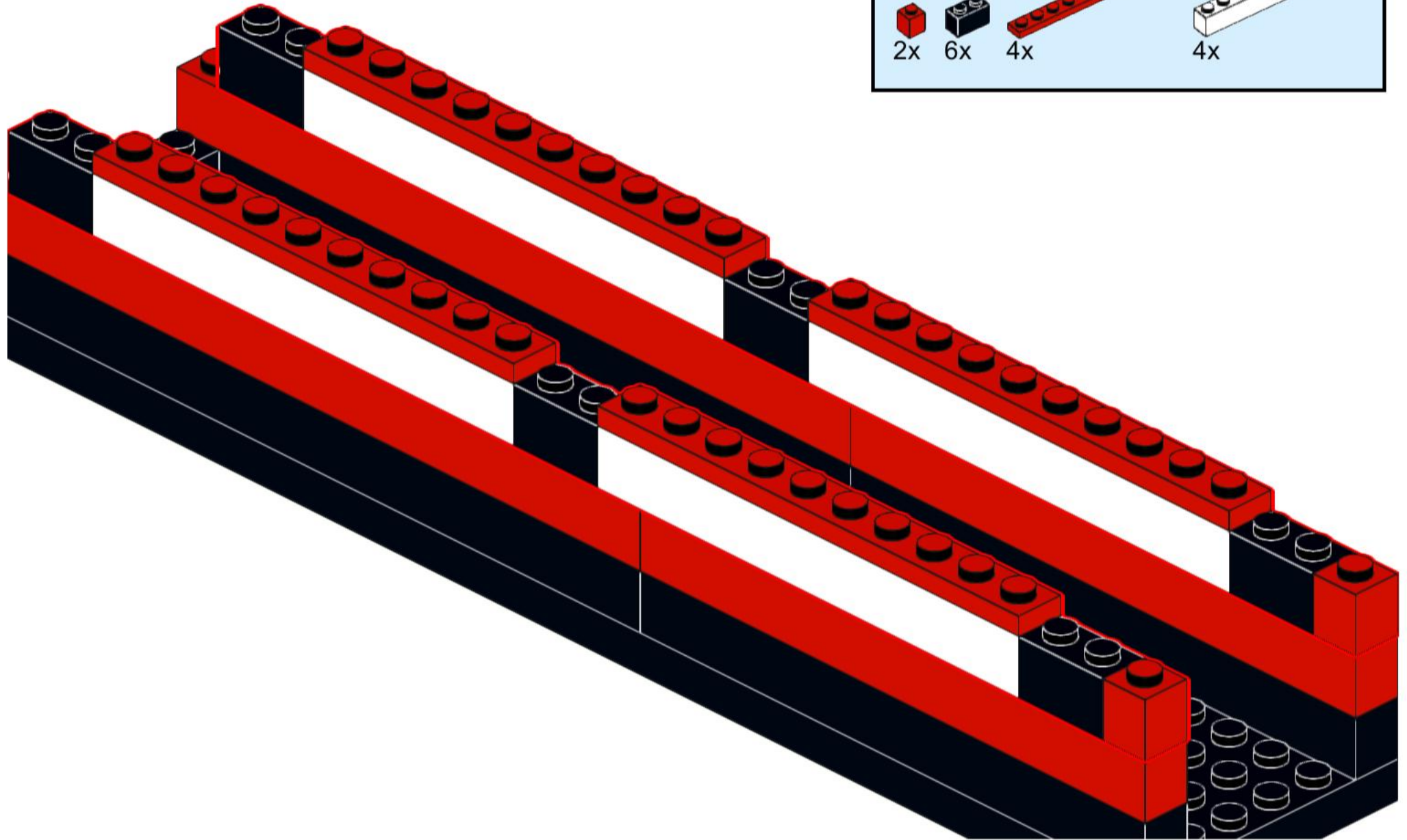

6

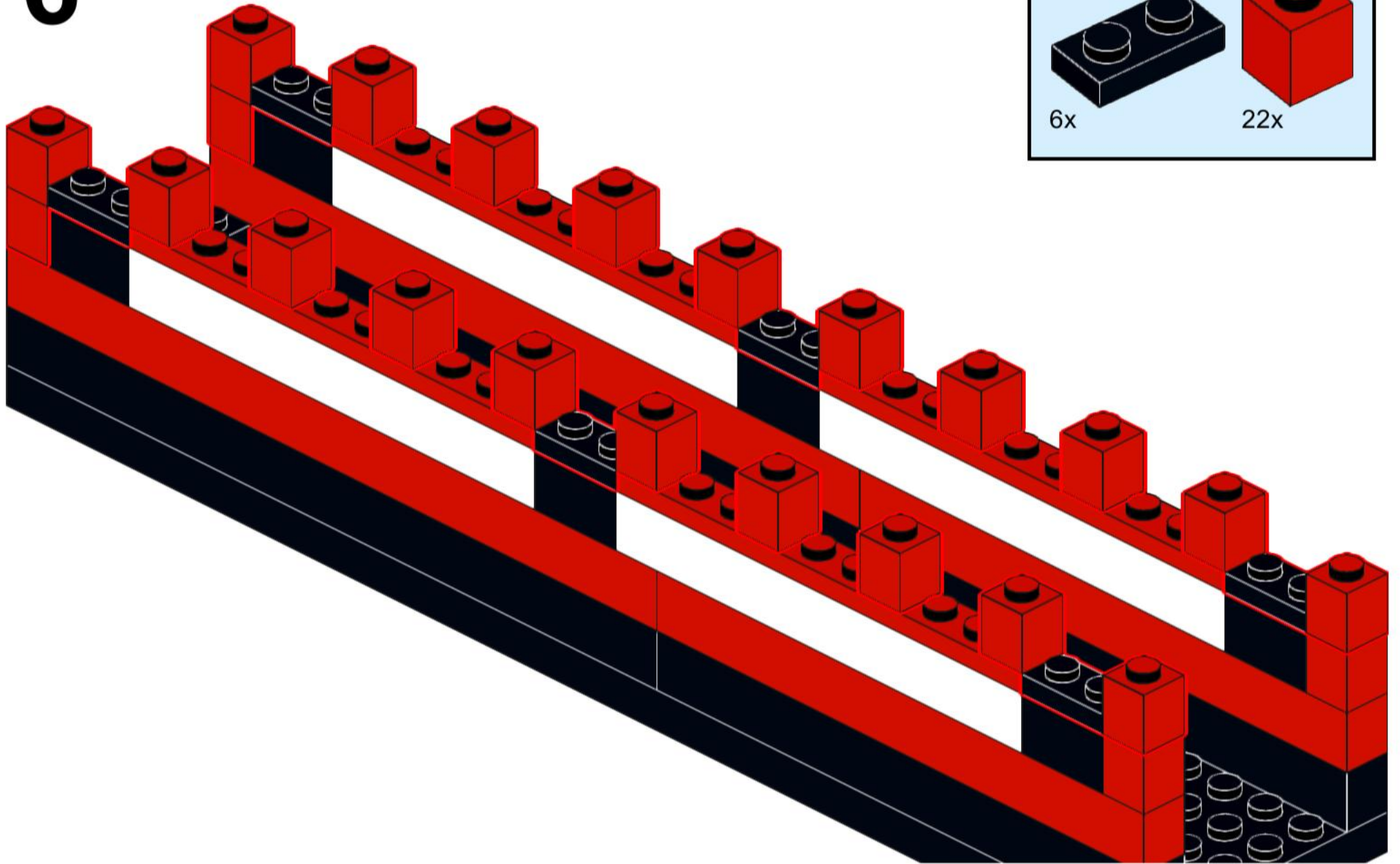

7

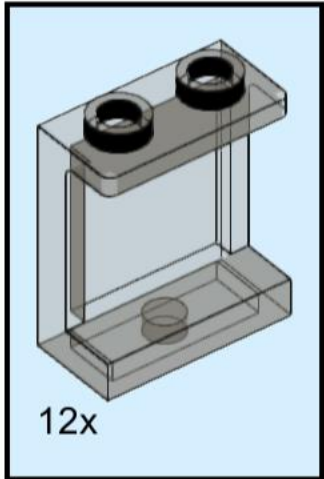
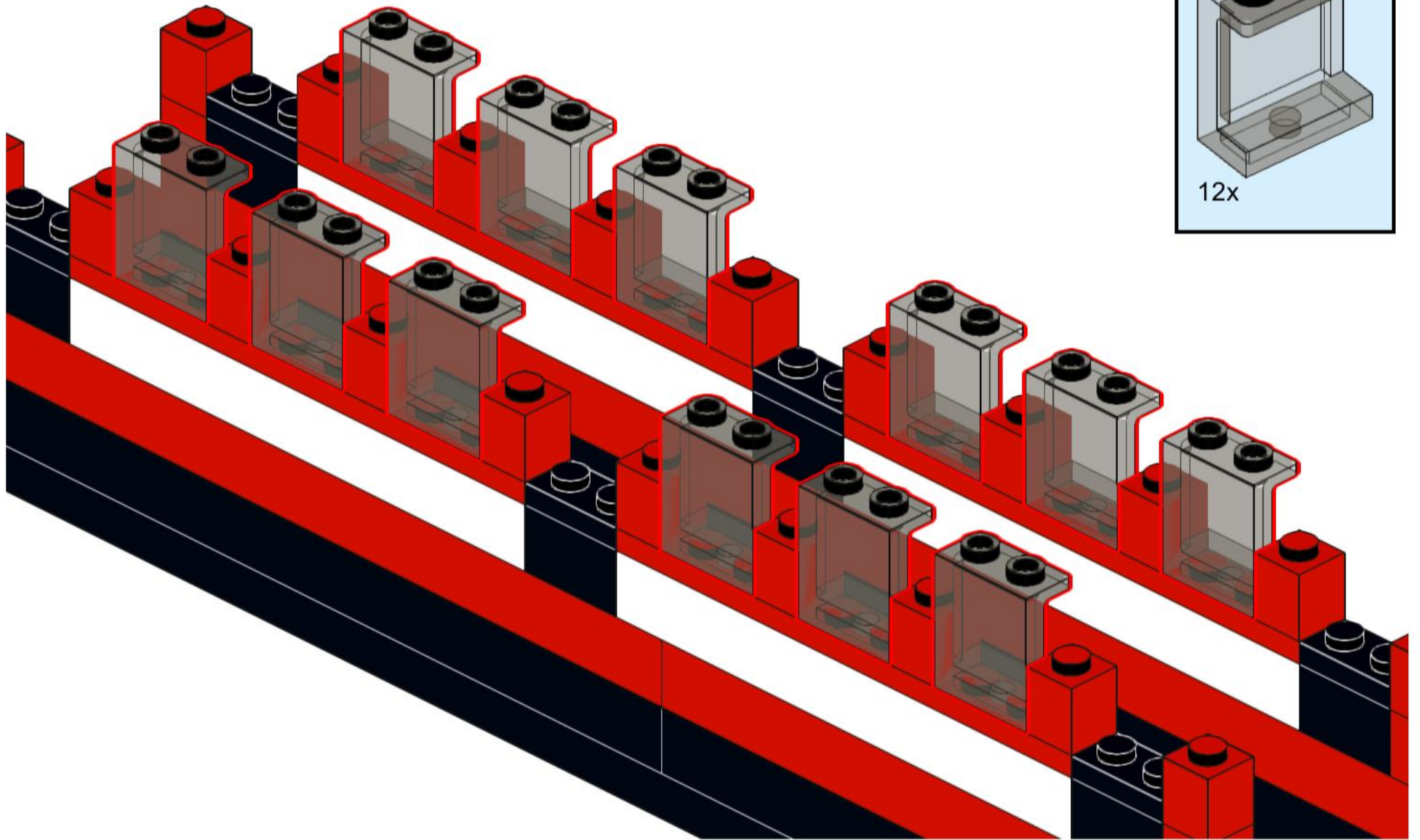

8

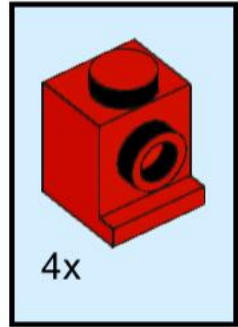
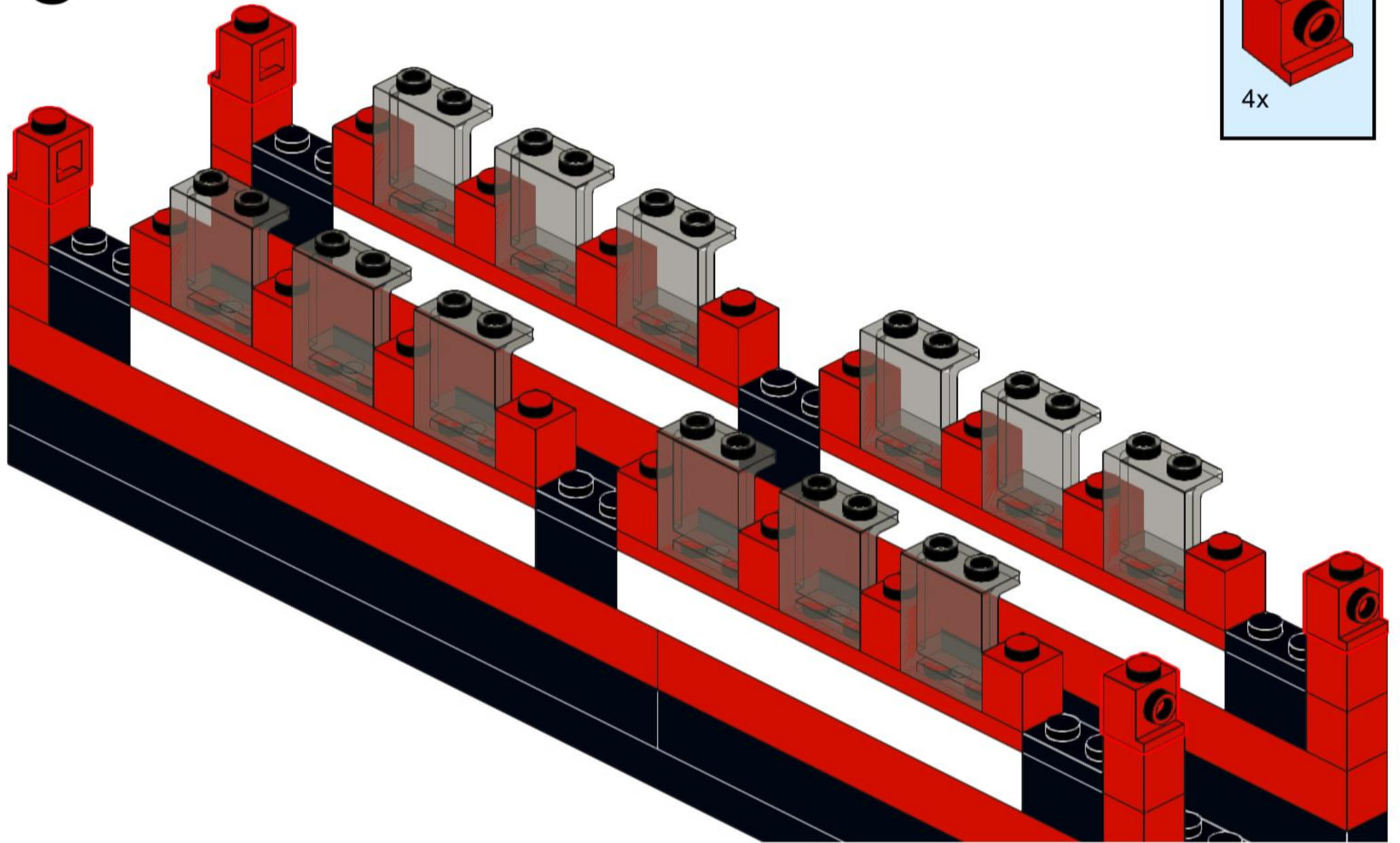

9

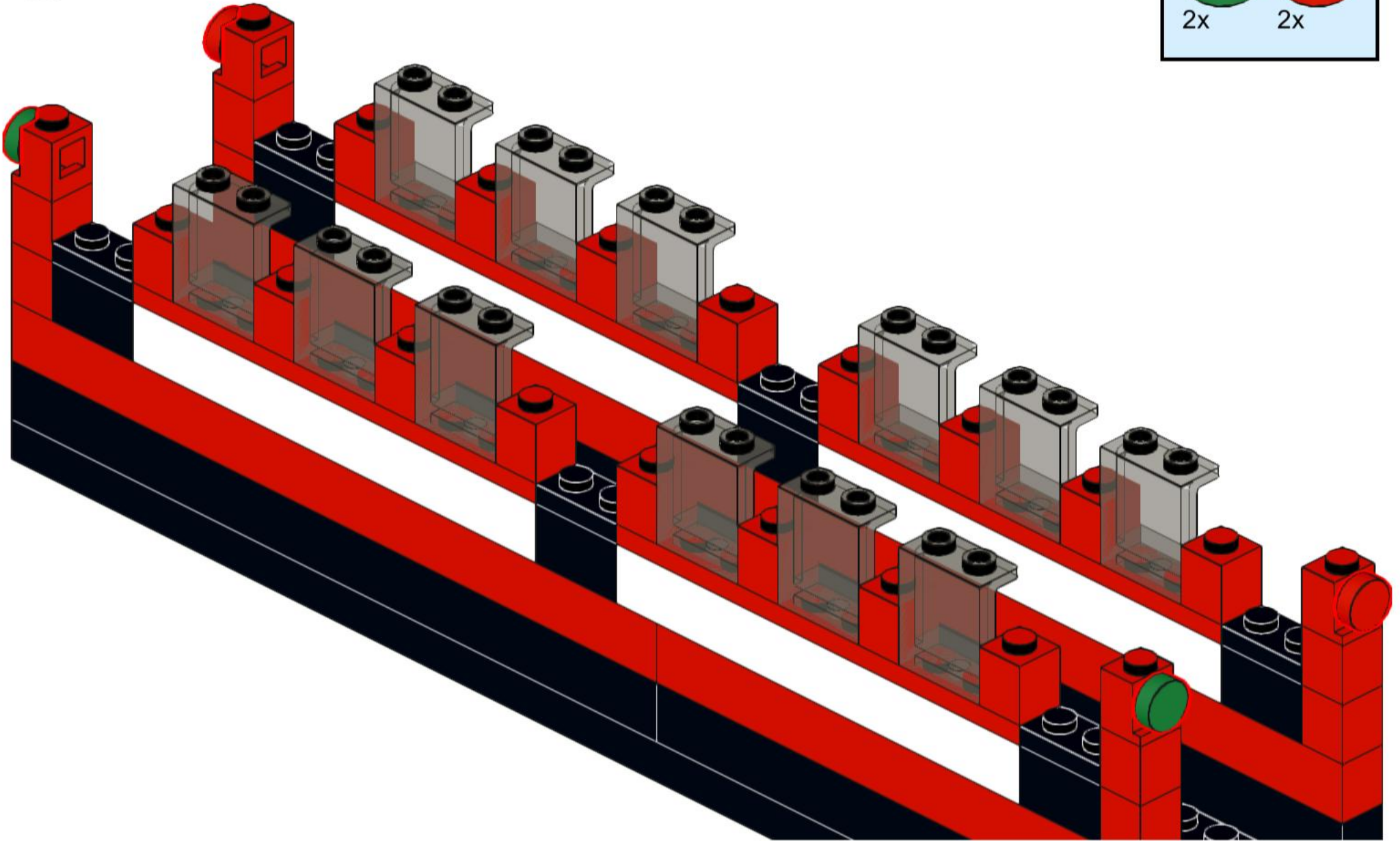
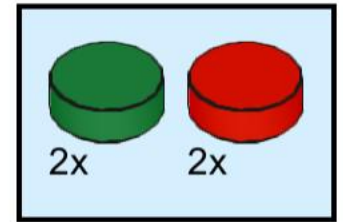

10

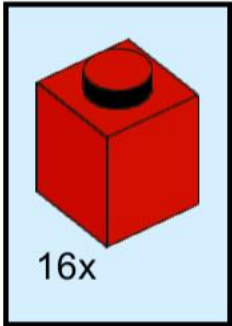
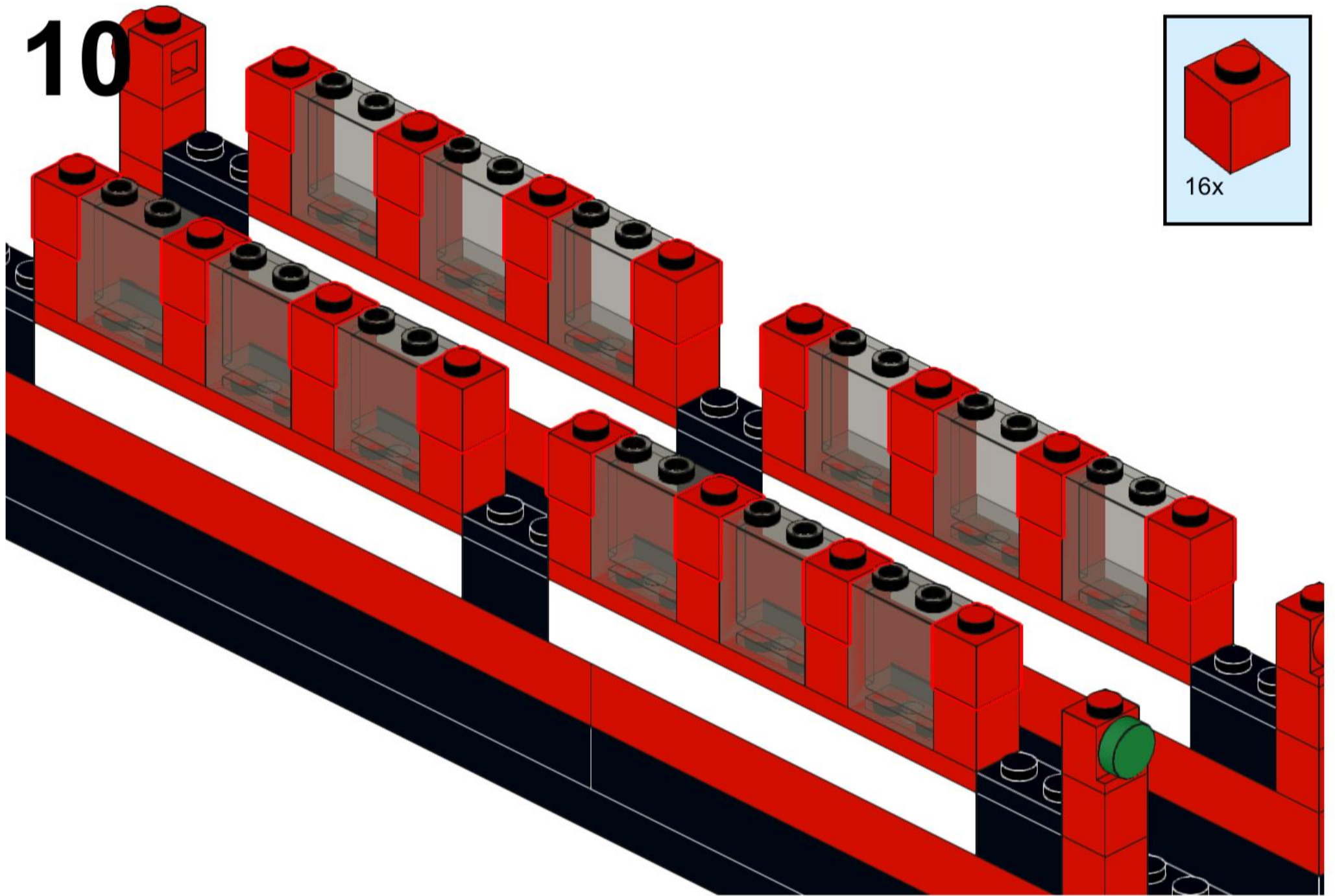

11

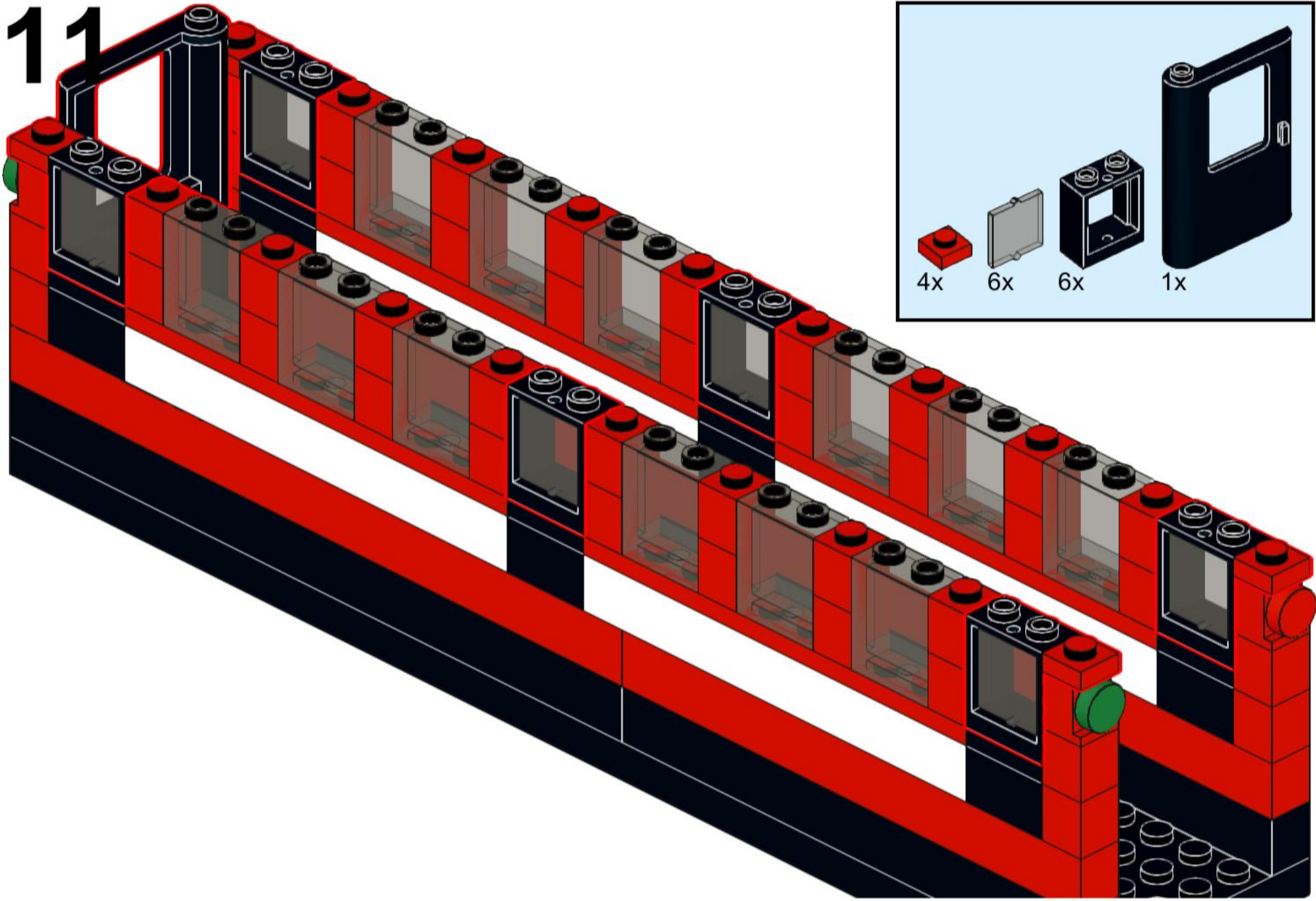

12

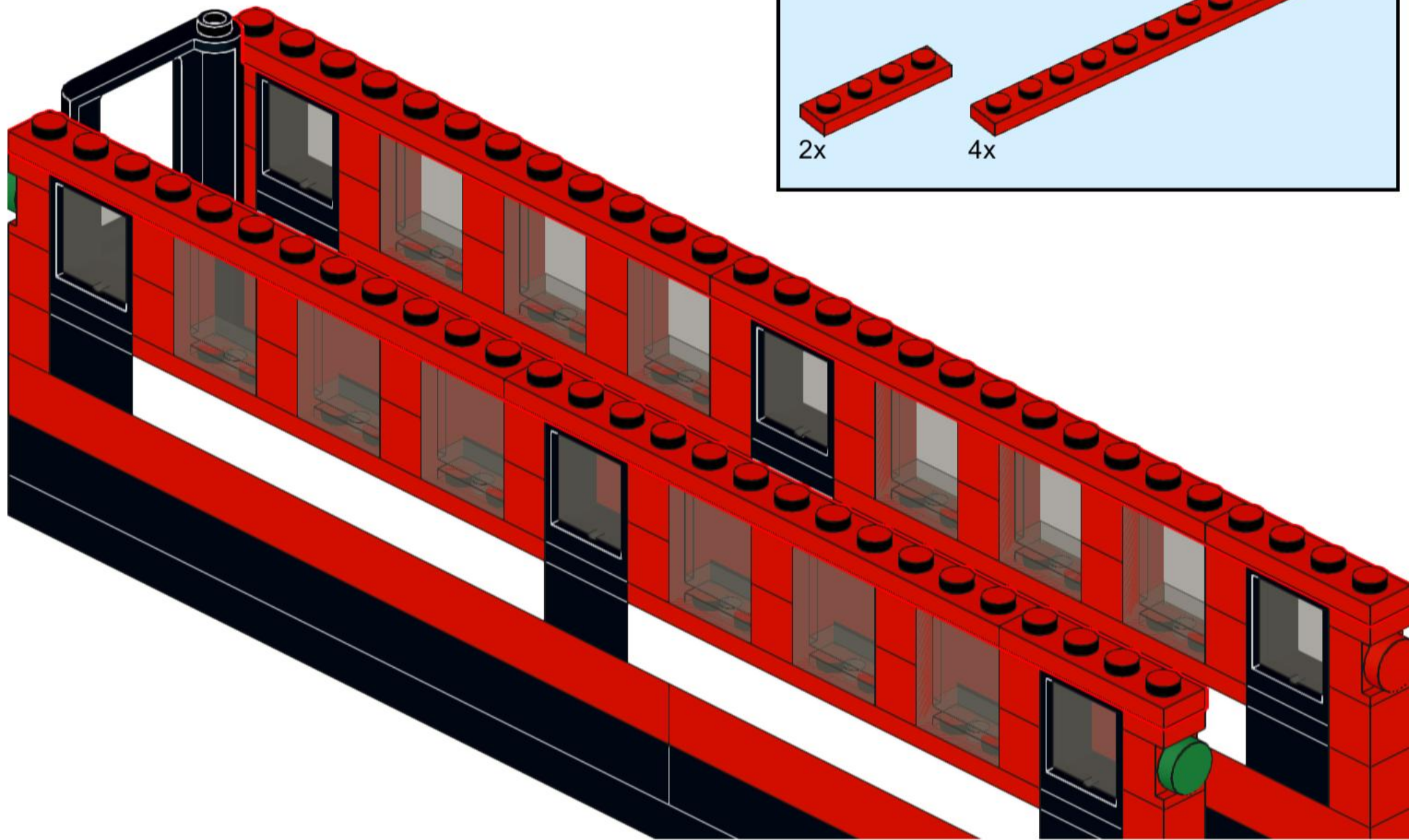

13

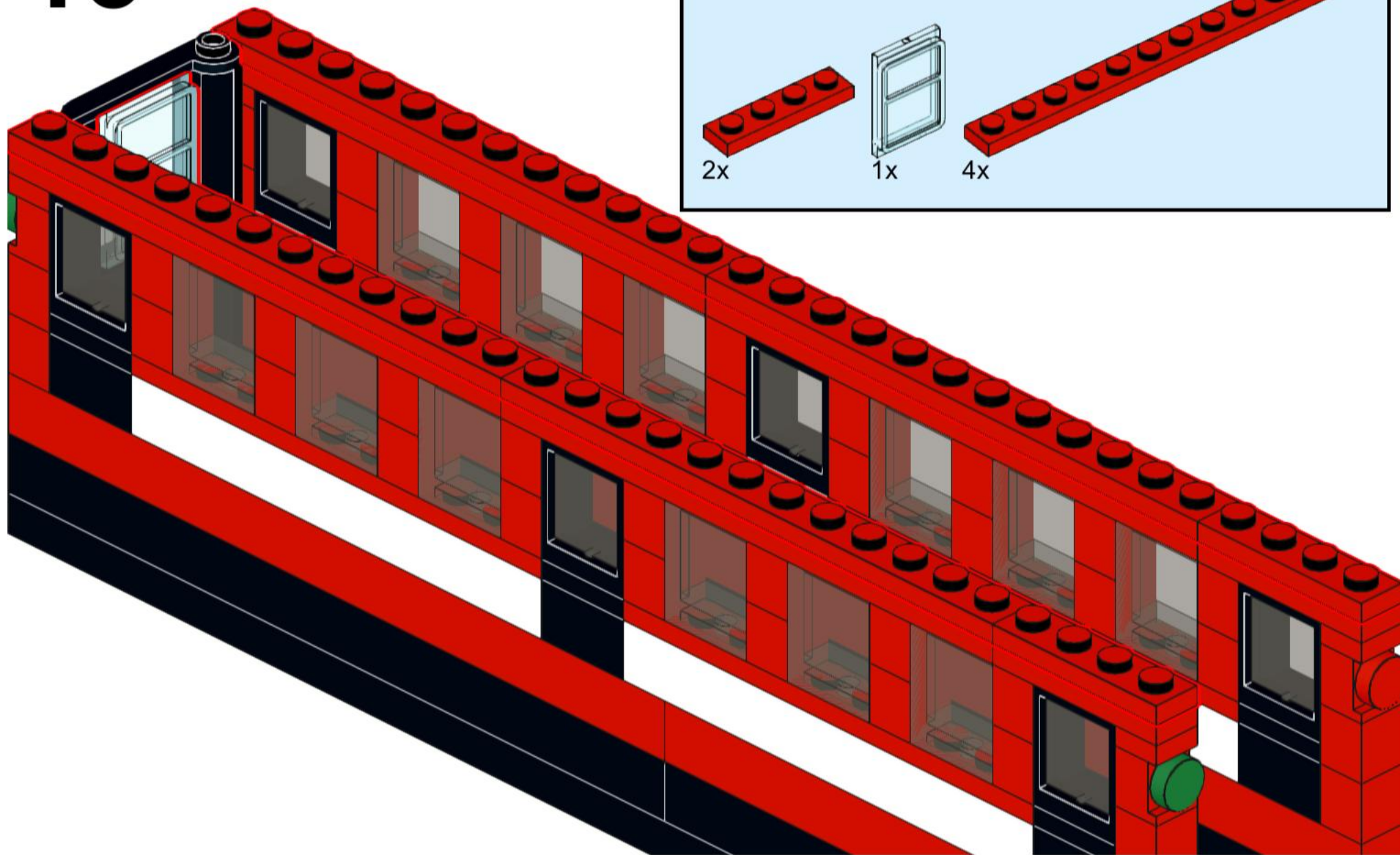
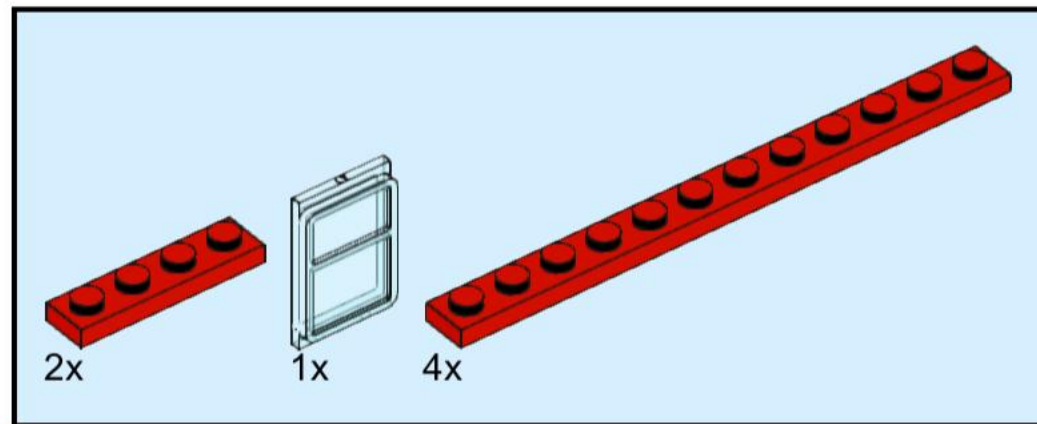

14

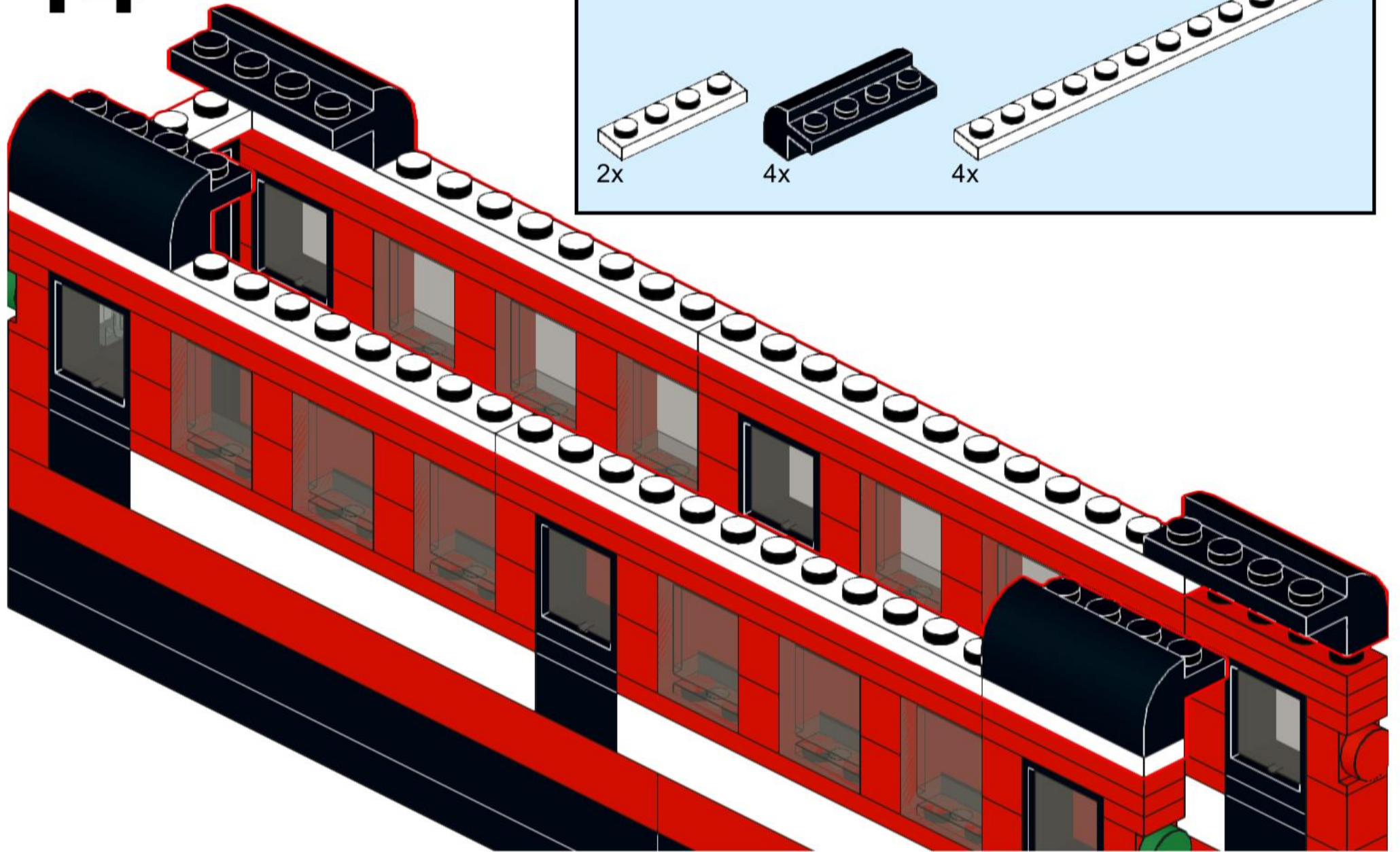
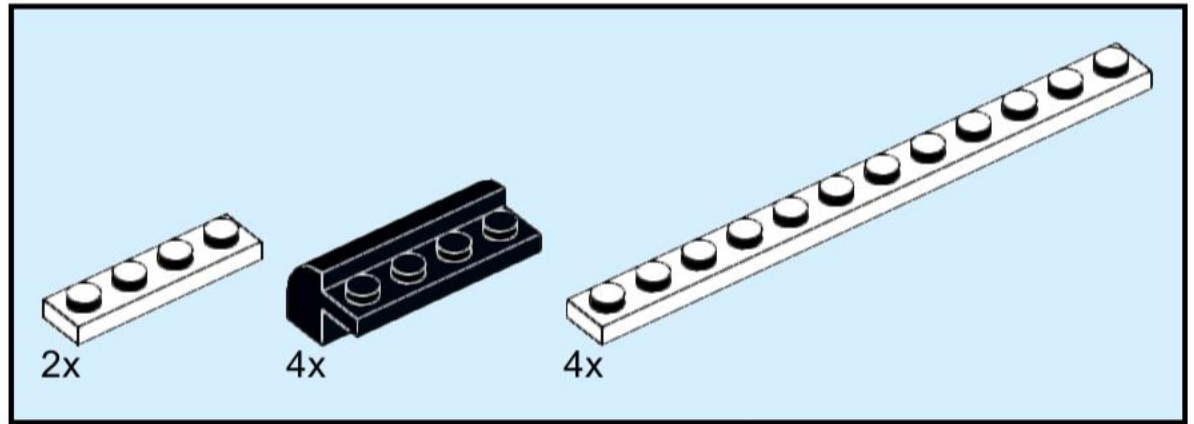

15

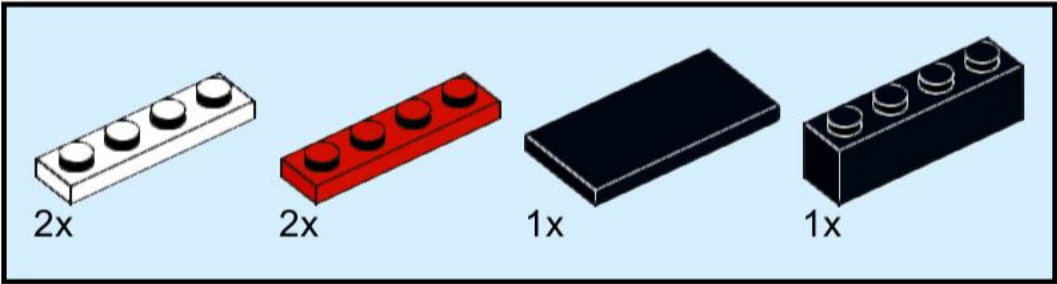
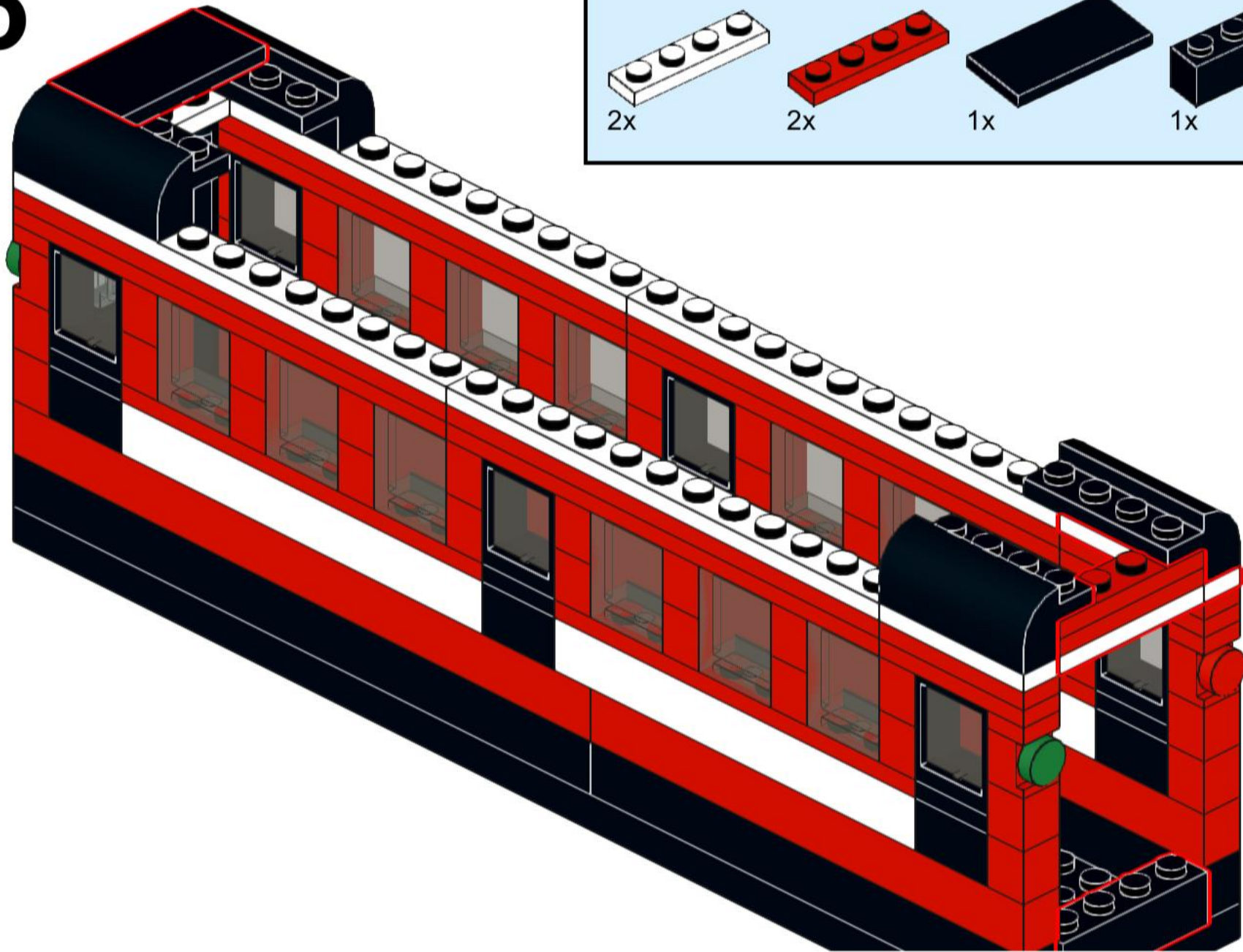

16

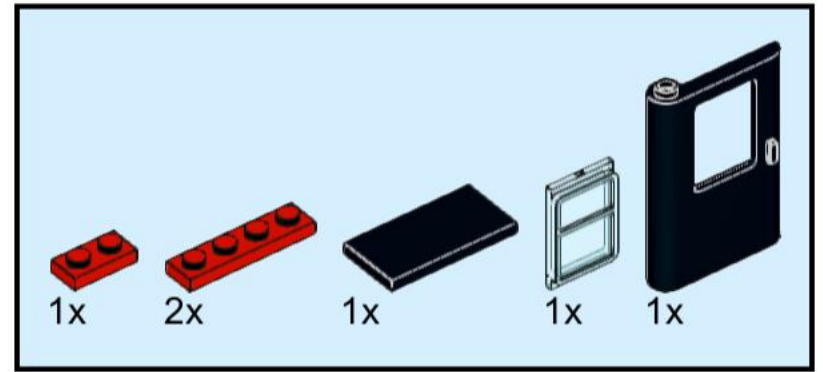
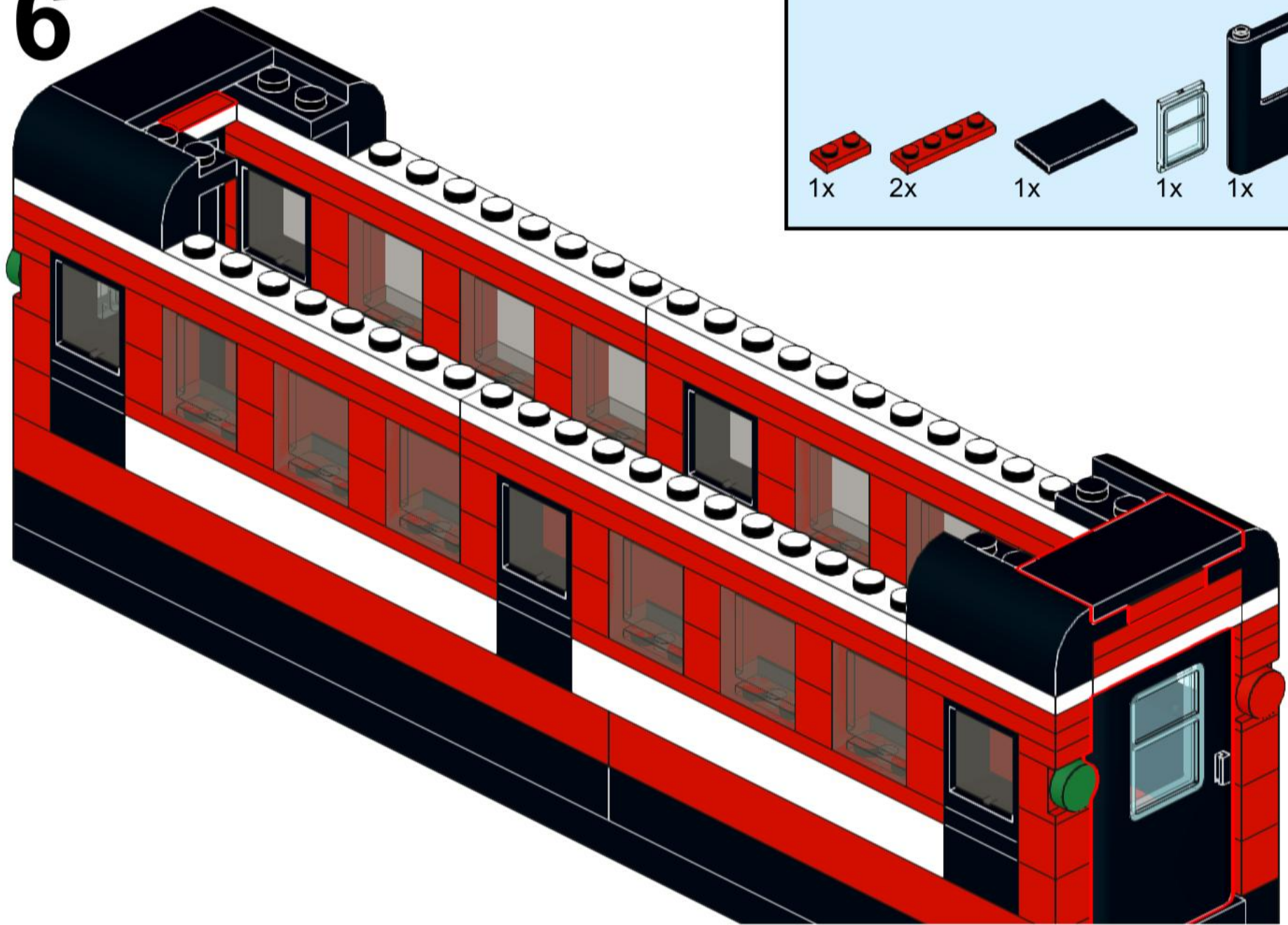

17

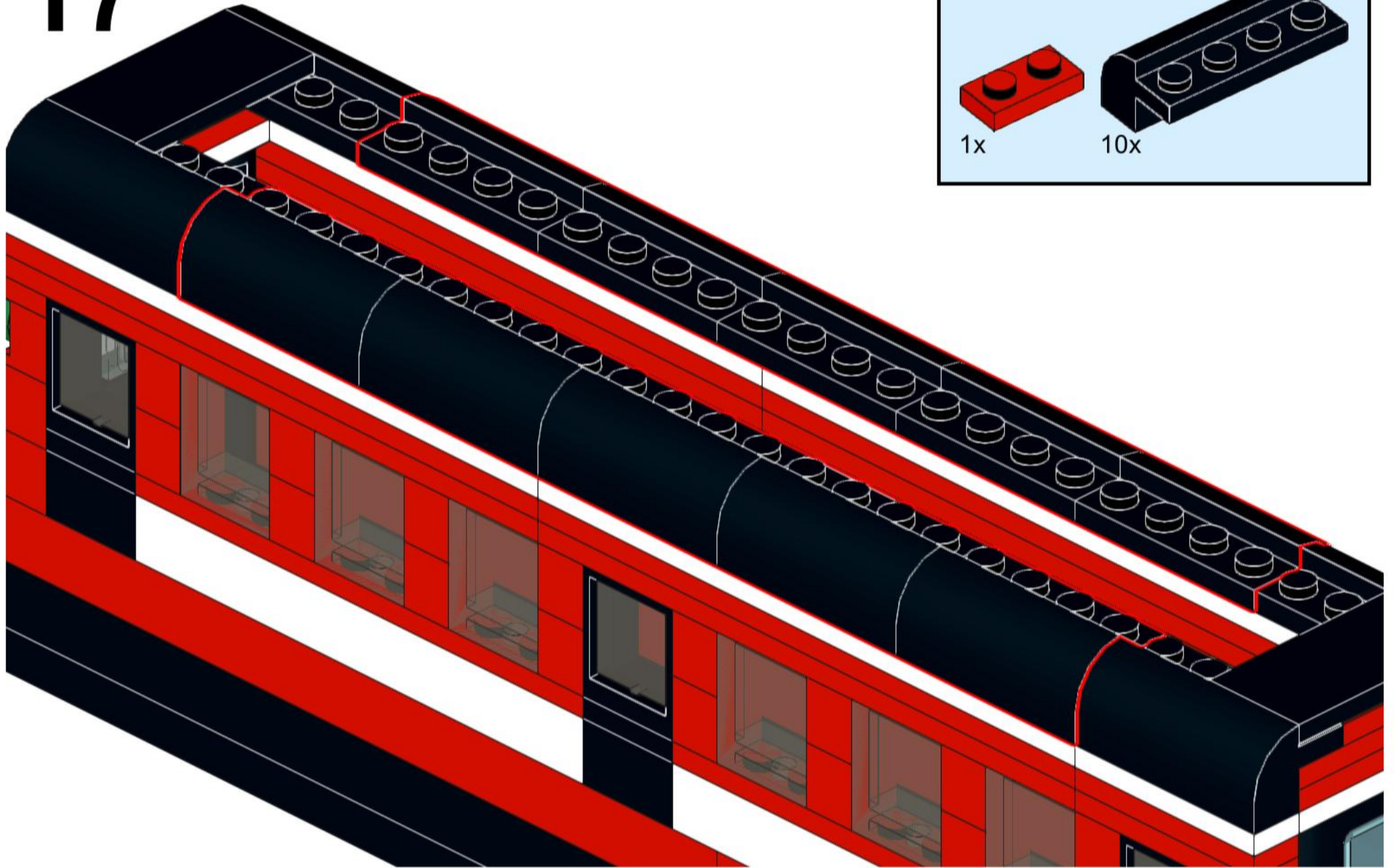

18

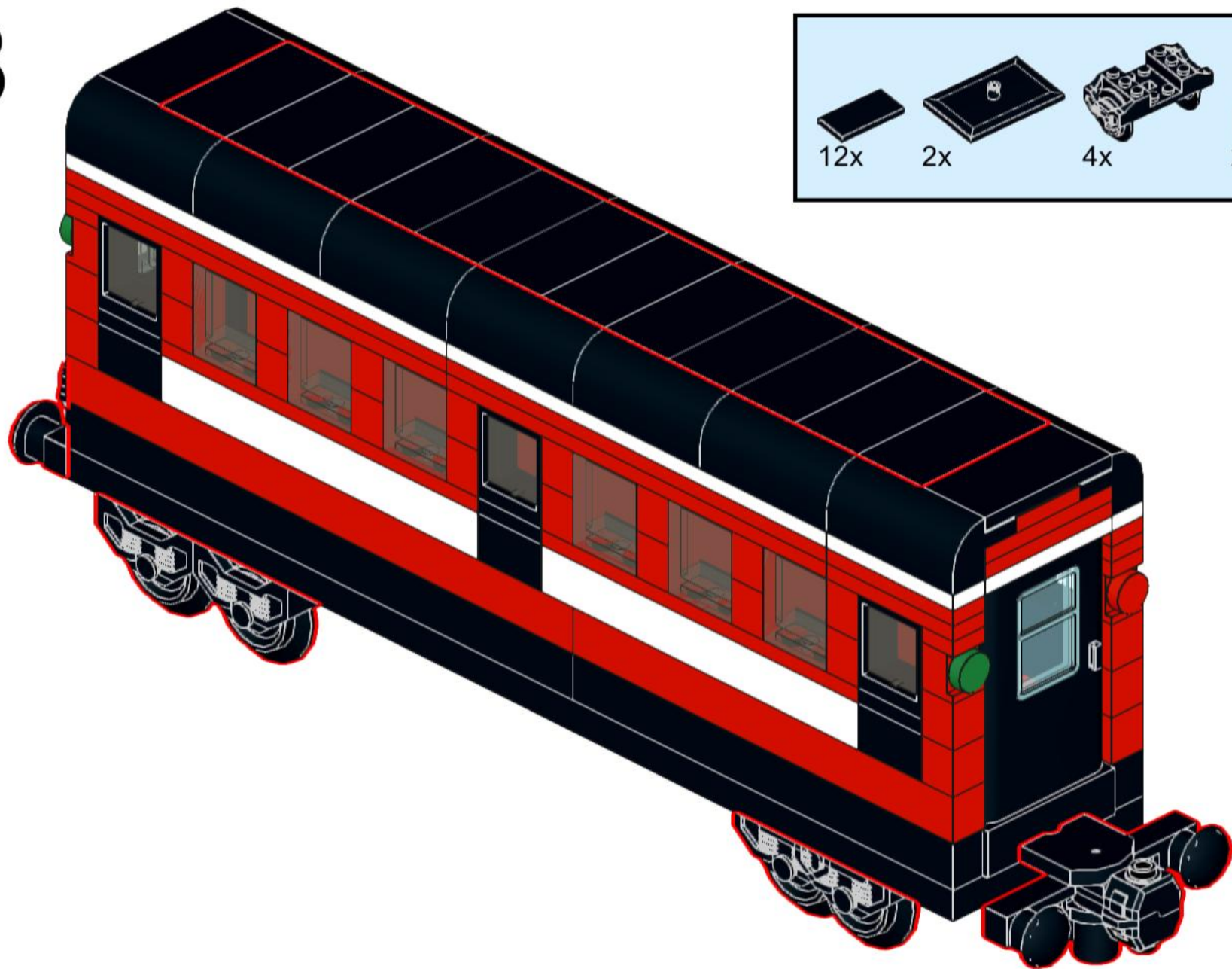

12x

2x

4x

2x